

INDOT
*Storm Water
Management
Field Guide*
2015



www.in.gov/indot

TABLE OF CONTENTS

INTRODUCTION	5
HOW TO USE FIELD GUIDE	7
PURPOSE	8
PROCESSES AND REQUIREMENTS	11
STORM WATER QUALITY CONTROL PLAN	11
OTHER ENVIRONMENTAL CONSIDERATIONS	12
STORM WATER MANAGEMENT INSPECTIONS	15
NOTICE OF TERMINATION	16
COMMUNICATION	21
WORK MANAGEMENT	22
STORM WATER MANAGEMENT	24
SLOPE DRAIN	26
COFFERDAM	30
PUMP AROUND	34
DEWATERING	38
DIVERSION INTERCEPTOR	42
ROCK CHUTE	46
EROSION CONTROL	51
VEGETATIVE BUFFERS	52
ROUGHENING	56
TEMPORARY SEED	60
TEMPORARY MULCH	64
DUST CONTROL	68

ROCK CHECK DAM	72
TRAVERSABLE CHECK DAM	76
EROSION CONTROL BLANKET	80
PERMANENT INLET PROTECTION	84
PERMANENT OUTLET PROTECTION	88
RIPRAP DITCH	92
PERMANENT SEED	96
PERMANENT SOD	100
SEDIMENT CONTROL	105
CONSTRUCTION ENTRANCE	106
SILT FENCE	110
SEDIMENT TRAP	114
SEDIMENT BASIN	118
FILTER BERM	122
FILTER SOCK	126
INLET PROTECTION	130
CULVERT INLET PROTECTION	134
OTHER POLLUTION PREVENTION	139
TEMPORARY CROSSING	140
MATERIAL STORAGE/STAGING	144
CONCRETE WASHOUT	148
APPENDICES	152
DEFINITIONS	152
DECISION MATRIX	154
REFERENCES AND INDOT LINKS	Back Page

Introduction

The Indiana Department of Transportation (INDOT) Storm Water Management Field Guide is a result of the Joint Transportation Research Program, Project No. C-36-68-DD, File No. 4-7-30, Indiana SPR-3312. This project also included updates to the INDOT Standard Specification, Standard Drawings and Design Standards.

This guide was created to provide guidance on the critical factors of management, understanding, setup, maintenance and removal of erosion and sediment control features that may be required for INDOT contracts.

The Field Guide is not intended to act as a contract document or design standard but as a visual and conceptual reference for INDOT projects requiring storm water management. INDOT Standard Specifications and Standard Drawings are referenced throughout the guide and should be used for additional information. The Indiana Department of Environmental Management (IDEM) Storm Water Quality Manual (2007) was used as a reference in the creation of this field guide. This guide is not intended to replace IDEM's manual but to enhance it and provide additional information such as photographs of Best Management Practices (BMPs) in a highway construction setting.

The Guide is organized with the intent of ease and efficiency of storm water management and follows a logical decision making process in its outline. Please use the Table of Contents on the previous pages or the Decision Matrix in the Appendix to determine which control features to consider.

How to Use Field Guide

This guide has organized Best Management Practices (BMPs) in a hierarchy of effective storm water management.

1. First, have good COMMUNICATION with all members of the team.
2. Then, plan for good WORK MANAGEMENT with effective phasing and scheduling to minimize water pollution.
3. Third, effective STORM WATER MANAGEMENT controls water flowing through the construction site.
4. Then, prevent soil particles from moving with good EROSION CONTROL.
5. Finally, once the potential for erosion exists, you must implement SEDIMENT CONTROL to prevent pollution from leaving the job site.

This hierarchy is one of the most effective and cost effective ways to manage a construction site for pollution prevention. Each chapter includes BMPs to help keep sediment and other pollutants from leaving the job site.

The appendix contains a decision matrix to help the user decide what BMPs could best solve a particular issue. This matrix contains page numbers to guide you to the BMP.

Purpose

Stream sediment is one of the most important water quality concerns in Indiana. Muddy water kills aquatic organisms, can increase the potential for flooding, and ruins wildlife habitat. Sediment laden water also carries pollutants such as heavy metals to waterways. Mismanaged construction sites contribute significantly more sediment pollution per acre than any other land use including agriculture. Effective storm water management on construction sites can significantly reduce storm water pollution. With numerous active construction sites every year throughout the state, INDOT can significantly affect Indiana's water quality.



Important environmental resource adjacent to INDOT roadway.

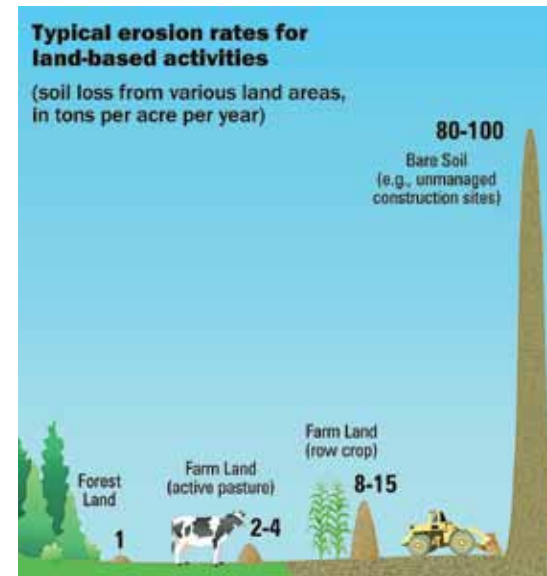

Mismanagement of construction sites contributes significantly more sediment pollution per acre than agricultural activities. Source: 2007 USEPA Developing Your Stormwater Pollution Prevention Plan: A Guide for Construction Sites.



Sediment from construction site filling in a stream. This is a violation of many environmental permits.

Storm Water Quality Control Plan

Unless otherwise stated within the contract special provisions, a minimum of 14 days prior to commencing work, the contractor shall provide a Storm Water Quality Control Plan to:

- Project Engineer/Project Supervisor (PE/PS)
- IDEM Rule 5 Coordinator
- INDOT Environmental Services

The plan shall be in accordance with 327 IAC 15-5 (INDOT-ES) and shall include:

- Areas not included in the Department submittal
 - a. Staging areas
 - b. Stockpiles
 - c. Haul Roads
- Changes initiated by the contractor
- Name of Storm Water Quality Manager
- Soil stockpile locations, storage areas, fueling locations, construction trailers, batch plants, and designated concrete truck washout areas.
- Construction phasing of erosion control measures.
- Construction entrance locations.
- Material handling and spill prevention plan.
- Monitoring and maintenance plan.

Off-site areas (borrow sites, etc.) require a separate Rule 5 permit

Storm Water Quality Manager Responsibilities:

- Quality Control Plan for Storm Water Management
- Obtain all other environmental permits
- Oversight of Storm Water Management Plan
 - d. Oversight of BMP installation
 - e. Weekly and post rain event inspections
 - f. Oversight of BMP maintenance
 - g. Oversight of BMP removal
- Accompany IDEM or other agencies during inspections

Standard References

Standard Specification Reference: 108.04 Prosecution of Work

Jurisdictional wetlands and waterways cannot be dredged, cleared, filled, re-routed or otherwise altered without one or more permits from the US Army Corps of Engineers, IDEM and the IDNR Division of Water. This includes the installation of temporary measures such as rock cofferdams and crossings.



Non-permitted wetland impacts. Equipment tracks have altered the wetland.

Keep vegetation on the banks and near jurisdictional waterways as long as possible. After work in a jurisdictional waterway is complete, the banks must be stable prior to allowing water to flow through the newly constructed channel.

Environmental permit review

- Locate project specific permits online.
- Link all permitted impacts to plans and contact INDOT-ES with questions.
- Know your permit conditions and the stream/wetland/habitat impacts.
- Do not exceed your permitted impacts without consultation with INDOT-ES.
- Commitments
 - a. Potential Indiana Bat tree clearing restrictions (no clearing April 1 - September 30).
 - b. Potential fish spawning restrictions (no in-stream work April 1 - June 30).
 - c. Be familiar with all environmental commitments.

Contractor Permit modifications and waivers

- Contractor reviews permits for any modifications or waivers.
- Temporary impacts permits possibly needed
 - a. Stream crossings
 - b. Causeways
 - c. Pump-arounds
- Waivers (when applicable)
 - a. Fish spawning (no in-stream work April 1 – June 30)
 - b. Indiana Bat tree clearing (no clearing April 1 – Sept 30)
- Additional impacts outside of construction limits
- Communicate needs to INDOT-ES
- Allow time for processing (several weeks or longer).
- Borrow/disposal areas need separate Rule 5 permit.

Storm Water Management Inspections

Description

Construction sites are exposed to the weather and are continuously changing. Therefore, a proactive storm water management plan and thorough inspections are needed to prevent storm water pollution. These inspections are a tool to keep job sites in compliance with Rule 5. No construction site is perfect; deficiencies are expected on these reports.

Standard References

Standard References: 205.07 Maintenance and Special Provision 108-C-192d: Storm Water, Erosion, and Sediment Control Inspection Report

Instructions

- Self inspections to be performed by the Certified Storm Water Quality Manager.
- Completed weekly and within 24 hours of ½" or more rain event.
- Reports shall be reviewed and signed by PE/PS.
- Reports must be readily available.
- Reports should note maintenance needed, additional BMP's needed and progress made.
- Deficiencies noted shall be addressed within 48 hours.
- Inspections should be proactive. Is there a potential for storm water pollution?
- Pictures are encouraged. They are a great way to document progress and prove efforts toward compliance.



Standard References

Standard Specification Reference: Construction Memorandum 14-02
IDEM Rule 5: 327 IAC 15-5

Description

Projects that disturb one or more acres of land require a Rule 5 permit. When the project is complete and the site is stable, a Notice of Termination (NOT) form is sent to IDEM to close out the permit. INDOT Environmental Services will submit this form after field staff has submitted the required pictures and documentation per the construction memo above. On LPA projects, the LPA owner (city or county) will sign the NOT form. Weekly and post rain event inspections must continue until the response NOT letter is obtained from IDEM.

Inspection

Before Environmental Services can issue a Notice of Termination for the Rule 5 permit, INDOT PE/PS and contractor must certify that:

- All temporary erosion and sediment control BMPs have been removed.
- The entire site has been stabilized (70 percent uniform density of permanent vegetation)
- No future land disturbing activities will occur

Completing permanent stabilization such as seeding and erosion control blankets as early as possible in the contract will give the vegetation time to germinate and establish prior to the end of the contract. Simply having the site seeded and covered in mulch is not enough to satisfy the stabilization requirement for the Notice of Termination (NOT). The NOT will not be issued until at least 70 percent uniform density of permanent vegetation is established. This vegetation must be healthy (green) thus reducing the potential for erosion problems after the contract is closed. Weekly and post rain event inspections are required until NOT is issued.

Successful Strategies

Successful Strategies for getting a timely NOT:

- Strip existing topsoil and redistribute it in seed and sod areas.
- Time permanent seeding for early September or late April.
- Test the soil to determine what amendments are needed.
- Sow seed into topsoil with adequate organic matter and fertilizers.
- Use erosion control blankets on long steep slopes.
- Water, mow or otherwise maintain grass as directed.

Examples



All temporary erosion and sediment control measures must be removed prior to issuing the NOT. Although the site is stable and more than 70 percent uniform density of vegetation, silt fence was left along the creek.



Good example of 70 percent uniform density vegetation.



This example does not meet 70 percent uniform density vegetation.



The site does not yet meet 70 percent uniform density but likely will with time. Final grade and seed as early as possible to allow more time for thick vegetation growth.

Communication

Good communication is essential to effective storm water management. No one communication plan will work for every contractor and every team. Below are a few successful strategies that can be used to help prevent storm water pollution.

Successful Strategies

Communicate Early

- Prior to bid, the contractor should communicate with subcontractors and suppliers about storm water quality bid items.
- The contractor, subcontractors, and INDOT should all be communicating storm water management issues and project phasing beginning at the Preconstruction Meeting.

Education

- Prior to installing any BMP, the Storm Water Quality Manager should communicate with the equipment operators on how they need to be installed. It is cheaper to install them correctly the first time and avoid having to repair them.

Contract Progress Meetings

- Storm Water Quality Managers should attend Contract Progress Meetings and be on the agenda each time. Keep storm water management and pollution prevention as an item on the schedule.

Feedback Loop

- Avoid repeat issues by ensuring there is communication to the entire team about problems and successes.

Qualified Professional

- The Storm Water Quality Manager shall have the INDOT Storm Water Quality Management Certification.
- Consider choosing a qualified professional, (i.e.: CISEC, CESSWI, CPESC Certified) as the Storm Water Quality Manager.
- The contractor's Storm Water Quality Manager should be qualified to assess the situation and provide a resolution on storm water management issues.

Team

- Communication should flow in all directions. Each team member (contractors, subcontractors, INDOT PEs, etc.) should keep each other informed.

Successful Strategies

Minimize Disturbance

- Managing construction operations to minimize disturbance or leave existing vegetated areas in tact as long as possible is one of the most effective ways to prevent erosion.
- Existing vegetation is approximately 97 percent effective in preventing erosion, costs nothing to install, and needs no maintenance.

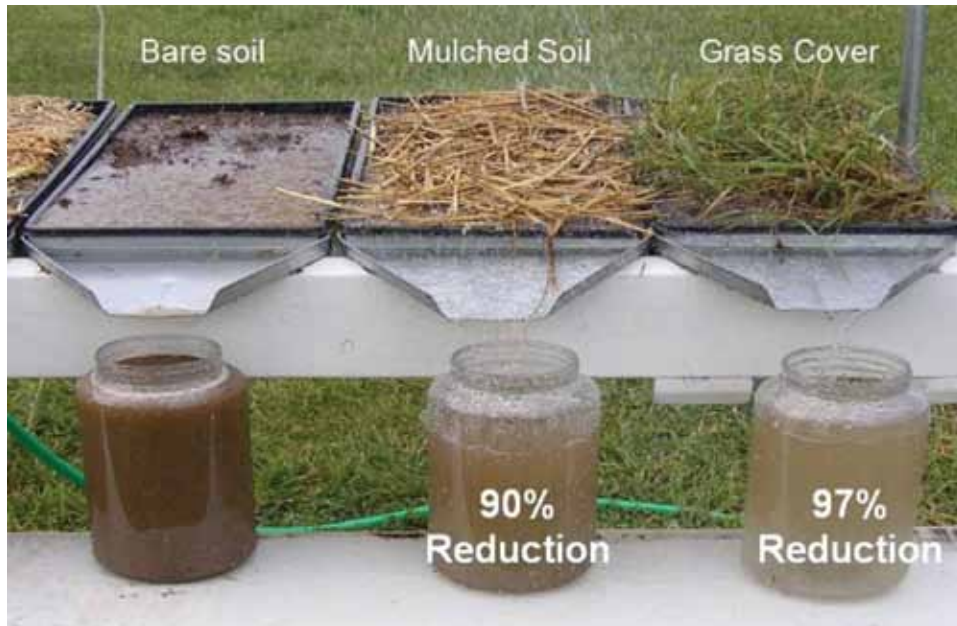

Photograph courtesy of Indiana Department of Environmental Management

Save Topsoil

- Strip topsoil and save it to use on slopes and ditches that will be seeded and sodded. Protect the soil stockpile with temporary seed and mulch.

Assembly Line Grading

- Plan grading operations like an assembly line, grade ditch, followed by tracking, followed by seeding and mulching.

Have a Plan “B”

- If a seeding subcontractor is not available, have a plan to accomplish the work anyway.

Timing is Everything

- Time grading operations so that permanent seeding can be completed in early September.
- Use weather forecasts for better storm water management.
- Schedule work to ensure site is stable prior to rain events.
- Seed and mulch exposed soil as soon as possible to prevent erosion and allow as much time as possible for vegetation growth.

Install Perimeter Protection First

- Prior to any earth disturbing activities, including tree clearing, install silt fence, sediment traps, filter berms, construction entrances and other BMPs to prevent off-site sedimentation.

Phasing

- Have a plan for each phase of construction and adapt the storm water management plan as needed in response to changing site conditions.

Prioritization of erosion and sediment controls for construction sites

Practice	Cost	Effectiveness
Limiting disturbed areas through phasing	\$	4 water droplets
Protecting disturbed areas through mulching and revegetation	\$ \$	3 water droplets
Installing diversion around disturbed areas.	\$ \$ \$	2 water droplets
Sediment removal through detention of all site drainage	\$ \$ \$ \$	1 water droplet
Other structural controls to treat sediment-laden flow	\$ \$ \$ \$ \$	0 water droplets

Generally the cheapest erosion and sediment controls are the most effective. For example, limiting the amount of bare soil by phasing your project and preserving existing vegetation is less expensive and works better than installing large storm water sediment basins or ponds. Source: 2009 edition KY Erosion Prevention and Sediment Control Field Guide.

Storm Water Management

Storm water flowing through disturbed areas causes erosion. Minimizing the amount of water flowing through the disturbed areas will decrease erosion.

Successful Strategies

Divert Off-Site Water

- Divert off-site storm water around disturbed areas through a stabilized channel so it does not have to be filtered. Off-site water that becomes dirty as it moves through a construction site must be filtered.
- Sediment control measures will not need to treat as much water and will require less maintenance.

Keep Water Off Slopes

- Divert storm water to slope drains or rock chutes to protect slopes while grass is getting established.

BMPs in a Series

- Rather than relying on one giant sediment basin at the end of the project to collect sediment (that will need to be redistributed), install a series of BMPs to keep water velocity low, erosion to a minimum and reduce BMP maintenance needs.

Identify the Hot Spots

- Wetlands and Streams
- Karst features
- Endangered species habitat
- Ponds, open water
- Fish, wildlife or plant resources
- Long and/or steep slopes
- Public roads
- Sediment and erosion beyond project limits

Often times, hot spots are low areas or areas where storm water leaves the job site. Manage the storm water to protect them from pollution.



Off-site water managed with a diversion interceptor and rock chute.



Silt fence and mulch protecting a wetland (hot spot).

Slope Drain



Standard References

Standard Specification Reference: 205.05(f) Slope Drains
205.07 Maintenance

Standard Drawing Reference: 205-TECS-02, 03, 04

Description

Slope drains are intended to serve as an aid to reduce the erosion and sediment transfer on constructed slopes. When properly constructed, the drains will collect the runoff storm water at the surface of the slope and direct the flow through an inlet end section into a pipe to a discharge outflow area at the toe of the slope. This outflow area should be stabilized as per the Standard Drawings to further reduce sediment transferred through the construction site.

Installation

- Construct a temporary diversion channel (see Diversion Interceptor on page 42) to divert runoff towards the inlet.
- Lay the pipe down the slope face, connect an inlet section to the pipe at the top of the slope, and anchor it in place.
- Extend the pipe beyond the toe of the slope to a stable grade with the end of the pipe on a riprap pad to protect the outlet from erosion.
- Construct a ridge over the inlet section of pipe by placing fill over the pipe in six-inch lifts. **Do not** compact with heavy equipment.
- Following installation, stabilize all areas down slope of the diversion.

Inspection

- Inspect weekly and within 24 hours after a ½" or more rain event.
- Inspect the installation for inlet/outlet erosion problems and pipe anchoring and leakage issues. Correct as necessary.
- Inspect for gullies and other potential areas where slope drains should be installed.

Maintenance

- Check the inlet for sediment or trash accumulation; clear and restore to proper entrance condition.
- Check the fill over the pipe for settlement, cracking, or piping holes; repair promptly.
- Check pipe for evidence of leaks or inadequate anchoring; repair promptly.
- Check the outlet for erosion or sedimentation; clean and repair, or extend if necessary.
- Once slopes have been stabilized, remove temporary diversions and slope drains, and stabilize all disturbed areas.

Example Installations



Slope drain is functioning; however it is not properly anchored.



Slope drains properly constructed with a stable outlet.

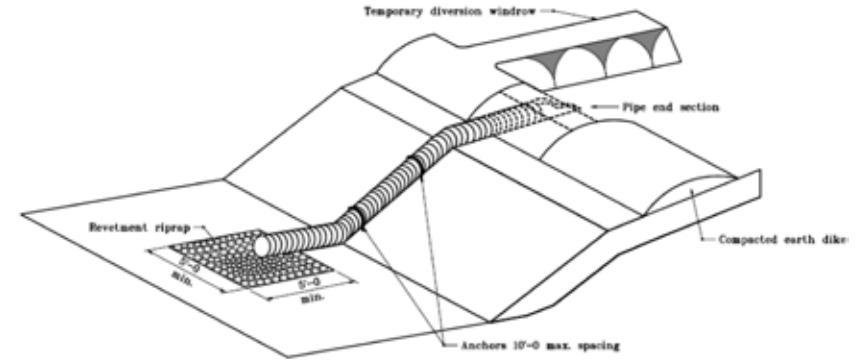

Typical Installation from Standard Drawing



Good example of slope drain diversion channel and inlet.



Slope erosion caused by lack of slope drain installation.



Standard References

Standard Specification Reference: 206.09 Cofferdams and Temporary Construction Dikes

Standard Drawing Reference: Drawings shall be supplied by the Contractor for the specific use or are shown on the plans.

Description

Cofferdams are temporary enclosures usually built within a body of water that, once built, are dewatered. Once dewatered, the cofferdam is either filled to produce a working platform or, left empty and used to construct a foundation within the water body limits. There are times when cofferdams can be utilized to protect a water area by being placed adjacent to the area of water closest to an active work area. The purpose for the use of cofferdams is to provide a dryer area to work within and to help sediment from the excavation/construction site from entering into the water body. Cofferdams must be constructed with materials that are impermeable and non-erodable.

Installation

- Ensure the proper permits, including 401/404 permits, are obtained for use of temporary cofferdams.
- Working drawings for a cofferdam installation shall be submitted by the contractor and will provide the method of construction for details not fully shown in the plans.
- Dewatering with sediment filtering shall be used (see Dewatering on page 38)
- Ensure all banks are stable prior to removal of cofferdams.
- Remove carefully with as little disturbance as possible.

Inspection

- Review all plans and working drawings for errors or omissions. Understand what is being built.
- Inspect the cofferdam installation to ensure the methods and location is correct.
- Inspect daily for leakage or bowing of the cofferdam sides. Report any deficiencies immediately. Ensure cofferdams are not tilted or shifted.
- If excessive water is entering work area, inspect for leaking areas such as joints.
- Review the location of the cofferdam. Report any movement immediately.

Maintenance

- Remediate any movement or bowing of the cofferdam body prior to re-entry. If cofferdams have tilted or shifted, straighten as necessary and brace to prevent future movement.
- Repair any leaks to the cofferdam body in order to provide a buffer to any sediment leaving the area.
- Regrade and reseed work areas adjacent to the water bank as soon as practical prior to removal of the cofferdam.

Example Installations



Permitted aggregate cofferdams used as working platforms.



Steel sheet piling used for a working platform within the waterway.



Bare earth is highly erodible and not a suitable barrier to be used for cofferdams. Water infiltration is evident.



Sand bags can be used as cofferdams.

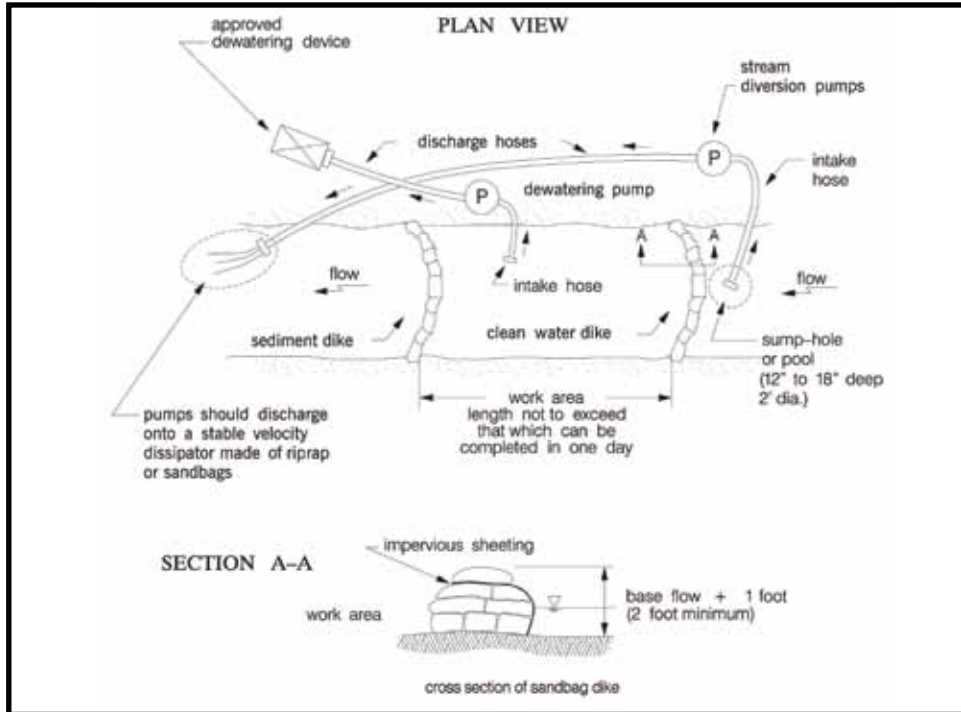

Maryland's Guidelines to Waterway Construction **DETAIL: 1.2: Pump Around Practice**

Standard References

Standard Specification Reference: 206.09 Cofferdams and Temporary Construction Dikes

Standard Drawing Reference: Details shown on plans and in environmental permits.

Description

A pump around should be utilized as a method of diversion for existing stream water. The purpose of the pump around is to isolate the jurisdictional water from the work area. This method of water control is usually designed specifically for a contract and will be detailed within the plans. This method may be used by a contractor in lieu of stream diversion to isolate the work area from the jurisdictional waterway.

Installation

- Place water tight cofferdams (see Cofferdam page 30) in the waterway upstream and downstream of the work area.
- Pump water from the upstream side, around the work area, and outlet on a stable outlet (usually riprap) on the banks of the waterway downstream of downstream coffer dam.
- Pump should be sized to ensure upstream water does not overtop the coffer dam and allow water into the work area.
- Stream water should not be allowed to flow through work area until the area is completely stable, which includes the final shaping of the disturbed stream banks and stabilization of those banks with riprap, erosion control blankets, etc.

Inspection

- Inspect daily during pump around operations.
- Inspect stable outlet and ensure stream bank is not eroding.
- Monitor the creek water level upstream to ensure pump is adequately sized and water does not flow over coffer dam.
- Monitor the weather forecast and anticipate increases in stream water levels.

Maintenance

- Adjust outlet stabilization if bank erosion is noticed.
- Adjust pump capacity as needed to handle stream water volume.
- Fix leaks or otherwise stabilize cofferdams if water is back flowing into work area.

Example Installations



Water tight cofferdam on upstream side with adequately sized pump.



Pump around was removed prior to channel bank stabilization.



Stable outlet should not be placed in the stream channel. This is unpermitted fill and a violation of 401/404 permits.



Pump around water does not need to be filtered. This filter bag and secondary containment is intended for the dewatering operations.

Storm Water Management



Standard References

Standard Specification Reference: 206 Structure Excavation

Standard Drawing Reference: Details shown on plans and in environmental permits.

Description

Dewatering may be used in a variety of construction operations such as to remove water from the bridge foundation footing excavations, drainage structure installations, or from fill areas prior to placement of the borrow materials. Proper outflow of the dewatering activity should be reviewed and planned for in the design of the system. The components of the dewatering process should include the use of water filtering and stabilized outlets. The filtering operation helps to greatly reduce the sediment transportation which is associated with the dewatering operation.

Installation

- Locate the desired outflow location for the dewatering system and coordinate the filter and stabilization method to be used with the installer.
- If possible, gravity dewatering can be used and must be filtered prior to flowing through a vegetated ditch or waterway.
- Discuss the pump capacity and piping components to be used with the installer. Review the layout of the system prior to placement and have any deficiencies corrected prior to operation activation.
- Construct a secondary containment BMP such as a rock filter berm or sediment trap near the waterway.
- Place filter bag on a flat stable surface outside of the waterway behind the secondary containment.

Inspection

- Inspect daily during dewatering operations.
- Inspect the filter location and condition for necessary repair.
- Review the piping system for leakage, kinks and conditions for needed repair.
- Inspect the filter bag for tears and sediment and water capacity.
- Look for erosion between the filter bag and waterway.

Maintenance

- Repair any pumps damaged or not operating properly.
- Repair or replace filters that exhibit leakage or failure.
- Filters may need to be replaced when they become laden with sediment.
- Repair or replace leaking or damaged piping.
- Repair eroded areas and stabilize.

Example Installations



Filter bag has been placed outside construction limits and in a jurisdictional wetland. This would be considered a permit violation and cause for work stoppage and possible fines.



Filter bag and sediment trap used to filter sediment from dewatering operation.



Filter bags should not be placed in waterways. Bags often break or become dislodged sending sediment downstream.



Filter bag placed on flat surface away from sensitive environments.



Standard References

Standard Specification Reference: 205.05(c) Diversion Interceptors
205.07 Maintenance

Standard Drawing Reference: 205-TECS-04

Description

Diversion interceptors consist of a single or a series of small ridges used to intercept and divert storm water runoff from long, narrow corridors and discharge it into a stabilized area or sediment treatment device. The diversion interceptors help to keep water from flowing down long embankments creating rills and gullies and carrying sediment to creeks, streams, rivers, and other sensitive areas.

Installation

- Construct the diversion to dimensions and grades shown in the construction plans or to general dimensions listed below.
 - a. Side slopes – ratio of 2:1 or flatter (3:1 or flatter if mowed).
 - b. Grade – positive towards outlet, but not exceeding one percent.
 - c. Stabilize for flow.
- Construct the diversion ridge in compacted lifts. Leave enough area along the diversion to permit cleanout and re-grading.
- Stabilize outlets prior to or during construction of the diversion and divert sediment-laden storm water flow to a sediment trap (Sediment Trap page 114) or a sediment basin (Sediment Basin page 118).

Note: Diversion Interceptors are also used in conjunction with temporary slope drains (Temporary Slope Drain page 26).

Inspection

- Inspect weekly and within 24 hours of a ½" or more rain event.
- Inspect daily if impacted by grading operations.
- Inspect ridge height.
- Check outlets for needed repair.

Maintenance

- Remove sediment from channel to maintain positive grade.
- Adjust ridge height to prevent overtopping
- Make necessary repairs immediately to outlets.
- Stabilize areas that are eroding.
- Reform diversion interceptors as needed if disturbed by grading operations.

Example Installations



Diversion interceptor directing water to a filter berm

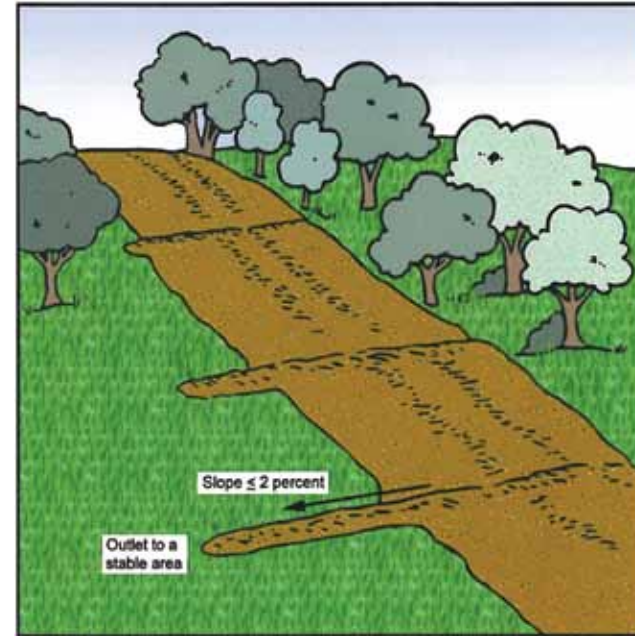

Schematic of Diversion Interceptor concept. IDEM. Indiana Storm Water Quality Manual. Indianapolis. October 2007



Stable diversion interceptor around a box culver installation. Diverted stream water should flow freely. Riprap should not be placed in channel.



Example of permanent Diversion Interceptor installation



Standard References

Standard Specification Reference: 616.01-08 Riprap, 616.10-11 Geotextiles

Standard Drawing Reference: Chute cross section in plans

Description

A rock lined chute is a water conveyance consisting of a lined channel used to move water down a slope in a non-erosive manner. Its main purpose is to reduce channel flow velocity and to provide a stable grade at the outlet to prevent erosion. Riprap is used to stabilize a channel but should not be used to collect sediment.

Installation

- Excavate and compact the channel prior to placement of geotextile. Construct the channel excavation with a swale depression through the length of the channel for flow direction. Riprap is recommended to be placed at a depth of twice the stone diameter or 12 inches, whichever is greater.
- Place geotextiles on the compacted, relatively smooth surface. Overlap Geotextile sheets 18" with the upstream sheet over the downstream sheet. Blend the lining material into the surrounding grade.
- Chute must be cut to final cross section/grade in a concave shape. Water shall be directed to flow down the middle of the rock chute and not along the sides causing erosion.

Inspection

- Inspect weekly and within 24 hours of a ½" or more rain event.
- Inspect channel geotextiles and lining materials for gaps, breaks, or washouts for necessary repairs.
- Inspect for any undermining of the channel and repair as needed.
- Look for any rills that may begin to form due to washouts or undermining and repair promptly.
- Inspect for sediment collecting in the riprap.

Maintenance

- If scour is found along the sides of the chute, reshape chute as needed for water to flow through the riprap.
- Promptly repair and reseed/mulch any small rills that form.
- Repair or replace any breaks, gaps, washouts or damage in the geotextile or the channel lining material.
- If sediment is found in the riprap, stabilize slopes and areas upstream of channel. Clean out or replace riprap.
- If scour is found downstream of the chute, additional riprap may be needed. Consult with designer and/or Environmental Services to ensure no permits or permit modifications are needed.

Example Installations



Good example of placement of a rock chute to help with runoff from an adjacent farm field.



Rock chute installed without proper swale depression causing erosion rills.



Rock chutes should have been used to stabilize slope. Erosion is causing large rills to form and sediment transportation is evident.

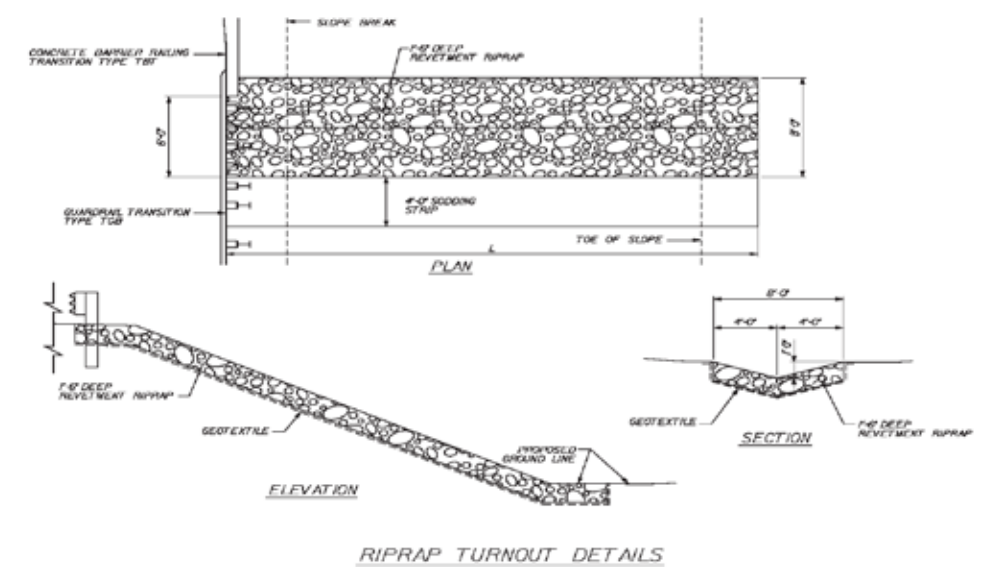

Riprap turnout details can be found in the plans with the miscellaneous details.

Erosion Control

Erosion control involves maintaining the soil on the ground, within the construction area, and minimizing its movement. Preventing erosion is more efficient and cost effective than managing sediment after it begins to be transported via storm water. Keeping soil in its place with good erosion control, minimizes the need for sediment control BMPs, reduces maintenance on those BMPs, and lowers costs of regrading.



Successful Strategies

Minimize Disturbance

- Preserve as much existing vegetation for as long as possible.
- If work that exposes bare soil is scheduled to be inactive for more than seven days, mulch and seed the area.

Protect the Soil

- Permanent seed as soon as possible
- Seeding and mulching are the least expensive and most effective erosion control measures.
- Erosion control blankets can also be used for temporary stabilization for bare or exposed areas. Blankets are very effective on long steep slopes.



Standard References

Standard Specification Reference: 205.05(g) Vegetative Filter Strips
205.07 Maintenance

Standard Drawing Reference: N/A

Description

Grass, shrubs, trees and other vegetation located above or below excavated areas should be preserved if possible. A vegetative buffer located above a construction site reduces water runoff velocity. Vegetative buffers located below construction site activity helps trap and filter sediment before it can move into ditches, channels and streams. All vegetated areas help to promote infiltration of storm water, which is a key objective in preventing erosion and controlling sediment movement off the construction site. Flat areas with sheet flow are a more effective buffer than steep areas or areas of concentrated flow.

Installation

- Evaluate existing vegetation and determine if it will serve as a filter strip (weeds are not an acceptable vegetative filter). Look for areas that are at least four inches high and cover 80 percent or more of the soil surface.
- If existing vegetation is not adequate, and site conditions and seeding conditions are favorable, overseed the area or fertilize the existing vegetation to enhance growth and density. Allow time for sufficient vegetative growth before discharging sediment-laden storm water runoff into the filter strip.
- Never use wetlands as a vegetative filter. Water should be filtered prior to entering wetlands.

Inspection

- Inspect weekly and within 24 hours after a ½" or more rain event.
- Inspect for the beginning of erosion rills or channel erosion.
- Inspect for accumulated areas of sediment.

Maintenance

- Promptly repair any small rills that form.
- Add fertilizer and soil amendments as needed to maintain healthy vegetation.
- Mow as needed but not shorter than four inches.
- Where the filter strip has actively trapped sediment during construction, remove the accumulated sediment, regrade the area and reseed it when conditions are favorable for vegetative establishment.

Example Installations



Narrow strip of vegetation on the bank is only partially protecting the stream. Note the sediment entering the waterway.



Existing vegetative buffer along and within the ditch.

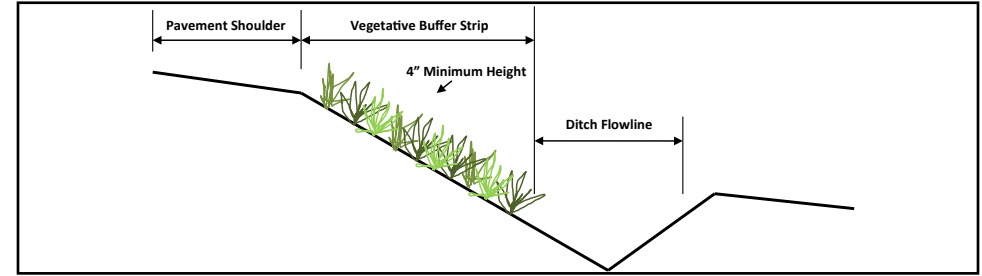

Vegetative buffer helps trap and filter sediment before it enters ditch flowline.



Good example of vegetative filter strip (and silt fence) protecting the waterway from sediment.

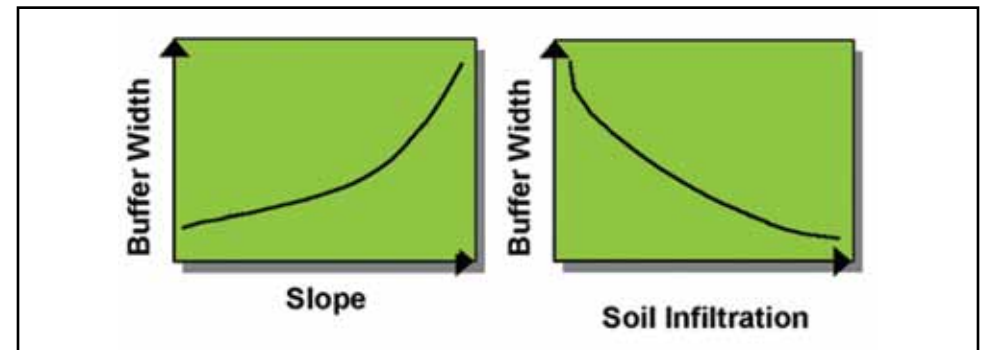

U.S. Department of Agriculture. Conservation Buffers: Design Guidelines for Buffers, Corridors, and Greenways. General Technical Reports SRS-109 September 2008.

Erosion Control



Standard References

Standard Specification Reference: 203.09 General Requirements
205.07 Maintenance

Standard Drawing Reference: N/A

Description

Surface roughening is the creation of ridges and depressions parallel to the contour of the slope to reduce runoff velocity and increase infiltration. A bulldozer track mark creates small ridges and valleys which help trap sediment and aid in establishment of vegetation. The track marks help to reduce the eroding effect of rain water as that water hits and travels down the slope. Without these track marks, and their roughening effect on the bare soil, the slope's resistance to erosion is greatly reduced.

Installation

- All slopes shall be roughened until permanent erosion control measures are placed. Roughening shall take place each day after work is performed on the slopes, or as directed to re-establish the roughening.
- Slopes shall be roughened to create a series of ridges and depressions **parallel to the contour** making grooves at least 1" deep and not more than 15" apart.
- Discuss the operation of roughening with the Storm Water Quality Manager to ensure understanding of the operation.

Inspection

- Inspect weekly and within 24 hours after a ½" or more rain event.
- Ensure that the ridges and depressions created by the track marks are in a horizontal direction and parallel to the contour of the slope.
- Check for rills and gullies.

Maintenance

- Promptly repair any small rills that form and re-roughen the repaired area when directed or required.
- As soon as possible, reinforce the slope roughening with an appropriate erosion control measure such as seeding and mulching.

Example Installations



Vertical tracking will contribute to rill erosion.



Operate bulldozer or other tracked vehicle up and down slopes before seeding to create tread-track depressions for catching and holding seed.



Horizontal tracking of slopes create small ridges and valleys to trap seed and mulch and help stabilize a slope.



Vertical roughening of slopes makes erosion worse and creates a series of rills to quickly move water and sediment to the ditch bottom.



Standard References

Standard Specification Reference: 205.04(a) Seed
205.07 Maintenance

Standard Drawing Reference: N/A

Description

Temporary seed is used to stabilize temporary soil stockpiles or bare soil surfaces until the areas are ready for permanent seeding. Temporary seeding can also be used to reduce problems associated with mud or dust on areas of disturbed bare soil during construction. Temporary seeding is one of the least expensive and most effective methods of erosion control and can reduce the potential for sediment-laden storm runoff.

Installation

- Temporary seed and mulch shall be placed on disturbed areas that are expected to be inactive for more than seven days.
- Prepare slopes by roughening the soil surface prior to temporary seeding. (see Roughening page 56) If soil is compacted, loosen soil to a depth of 2-3" prior to temporary seeding.
- Apply temporary seed mix uniformly over the disturbed, bare soil areas expected to be inactive for seven or more days, or as directed.
- Install the seed by drilling, hydroseeding, hand broadcasting, or other approved method that provides a uniform distribution.
- Do not cover the seed with more than one-half inch of soil.
- Mulching should take place within 24 hours after the seeding operation. (see Temporary Mulch page 64)
- When directed, fertilizer may be applied at 400 lbs./acre (one-half the permanent rate) during the active growing season from March through November.
- Temporary seed application rates:
 - Spring Mix: January 1 to June 15 (oats at 150 lbs/acre)
 - Fall Mix: September 1 to December 31 (winter wheat at 150 lbs/acre)

Inspection

- Inspect weekly and within 24 hours after a ½" or more rain event.
- Look for eroded areas, rills and gullies
- Adequate stabilization is approximately 80 percent vegetation density

Maintenance

- Repair eroded areas by reworking the area and reseeding promptly.
- Apply Mulch to reseeded areas within 24 hours.
- Fertilize if needed.

Example Installations



Weeds indicate slope has been unprotected. Temporary seed and mulch should have been applied within seven days of inactivity.



Early stages of temporary vegetation providing slope stability.



Temporary vegetation and slope drains providing slope stability.



Temporary seeding on long steep slope requires maintenance.

Erosion Control



Standard References

Standard Specification Reference: 205.04(b) Mulch
205.07 Maintenance

Standard Drawing Reference: N/A

Description

Install temporary mulch to prevent erosion by protecting the soil from wind and water impact. Mulch helps to stabilize slopes, prevent soil from crusting, conserve soil moisture, moderate soil temperature, and promote seed germination and seedling growth.

Installation

- Mulch can be straw, wood chips or other per 914.05 Mulch
- Install temporary straw mulch uniformly and at a rate of 2.5 tons per acre
- Install within 24 hours of seeding
- Mulch shall be secured with tackifier, netting, by punching with discs, cleating with dozer tracks, or other method to hold it in place.
- Punching or cleating should be horizontal or along the contour
- Mulch is not effective in ditch bottoms or other concentrated flow areas

Inspection

- Inspect the day of application to ensure uniform coverage.
- Inspect weekly and within 24 hours after a ½" or more rain event.
- Check for mulch movement and eroded areas
- Inspect until vegetation is established.

Maintenance

- Smooth eroded areas, reseed and reapply mulch as needed
- If erosion is severe, reoccurring or in channelized flow, consider erosion control blanket and/or slope drains.

Example Installations



Temporary mulch applied too thin contributing to erosion. Application rate should be 2.5 tons per acre.



Wood chips from tree clearing used as erosion control.



Mulch applied adequately and uniformly.



Stockpiled soil protected with mulch.



Standard References

Standard Specification Reference: 107.08 (b) Dust and Air Pollution

Standard Drawing Reference: N/A

Description

Dust control, especially during dry hot conditions, helps reduce wind erosion. Methods can include watering, resin/polymer application (in accordance with local, state, and federal regulations), mulching, street sweeping, and temporary vegetative covers. A pro-active approach should be used for effective dust control.

Installation

- The contractor and INDOT PE/PS should discuss the location of haul roads at the pre-construction conference to determine the best method to utilize for dust control. If possible, locate haul roads away from residential, commercial or other public areas.
- Apply water at a rate to keep soil wet/moist, but not saturated or muddy.
- If sweeping is a chosen method, wet the area with water prior to the sweeping operation to aid in dust suppression.

Inspection

- Be aware of the potential for dust as the season progresses and keep discussions on the issue open between the contractor and INDOT PE/PS.
- Inspect as needed, daily during hot and dry seasons. Be proactive. Stay ahead of the issue.

Maintenance

- Apply additional water or mulch as needed to control dust. Repetition is required for effective control.
- Keep construction equipment speeds to a minimum.
- Stabilize disturbed areas with vegetation and mulch as much as possible.

Example Installations



Dust contributes to air pollution, can interfere with drainage and can create traffic hazards.



Covering exposed soil with mulch is an effective dust control practice.



Sweeping paved surfaces reduces dust from vehicles.



Temporary seed or permanent seed as early as possible to reduce dust on a construction site.



Standard References

Standard Specification Reference: 205.05(a) Check Dam
205.07(g) Maintenance

Standard Drawing Reference: E 205-TECD-01

Description

A rock check dam consists of geotextile fabric and aggregate, placed across drainage channels to slow storm water runoff. This measure is primarily to prevent channel erosion in roadside ditches but may also provide limited sediment control. Rock check dams should not be used as a substitute for other erosion control BMPs (seed and mulch) and sediment control BMPs (sediment traps).

Installation

- Discuss and identify the areas for rock check dam installation
- Place revetment riprap on geotextile fabric that extends downstream of check dam.
- Include #5 or #8 filter stone on upstream side.
- The weir (lowest part of the dam) should be in the middle with the sides tied into the slopes. (Like a smile ☺)
- Space check dams so that the bottom of the upstream dam should align with the weir of the downstream dam.

Inspection

- Inspect weekly and within 24 hours after a ½" or more rain event.
- Check to make sure center of dam is low and the sides are tied into the slopes so water flows across center of dam.
- Check for #5 or #8 filter stone on front face of dam.
- Geotextile under dam should extend 3 feet down slope.
- Inspect for channel erosion. If channel erosion is found, space check dams closer so that the bottom of the upstream dam is aligned with the weir of the downstream dam.

Maintenance

- Remove sediment once it reaches one-half the height of the check dam.
- Repair or replace if damaged or ineffective.

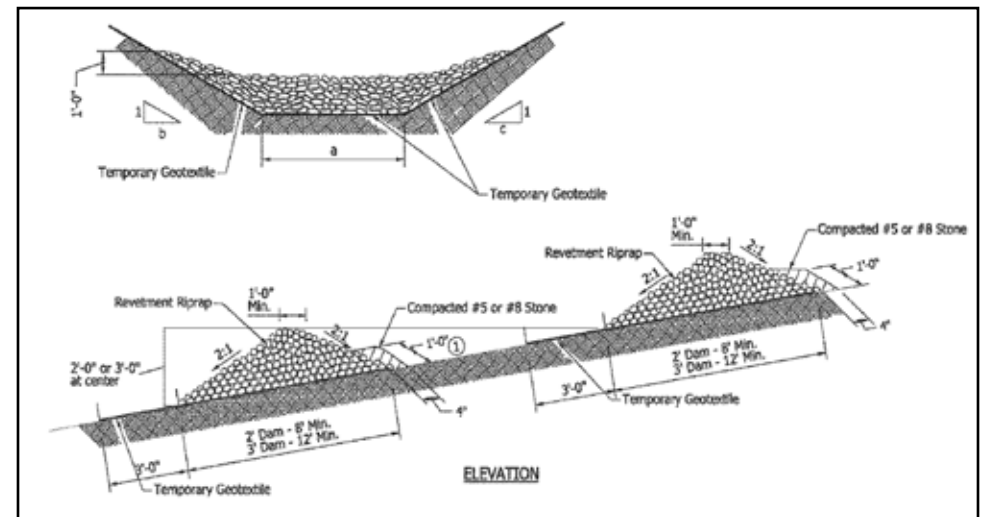

INDOT Standard Drawing, Temporary Check Dam, Revetment Riprap.

Example Installations



Check dam is much bigger than necessary.



Check dam shaped correctly with low weir in the middle and tied into the slopes.



Check dam not shaped correctly causing water to bypass dam and erode slopes.



Rock check dam not built to specification. Not shaped correctly, no filter stone, no Geotextile.



Standard References

Standard Specification Reference: 205.05(b) Check Dam, Traversable
205.07(g) Maintenance

Standard Drawing Reference: E 205-TECD-02

Description

Traversable dams should not be utilized as a first choice when selecting a channel erosion control measure. This option should only be used in clear zones with active traffic and when watersheds and velocities are small. A traversable check dam consists of geotextile fabric and soft material such as straw or filter socks, placed across drainage channels to slow storm water runoff. This measure is primarily to prevent channel erosion but may also provide limited sediment control.

Installation

- Place only in clear zone areas with active traffic and low storm water velocity.
- Place straw bales or filter socks on geotextile fabric that extends downstream of check dam.
- Trench the bottom of the check dam into the ground 4 inches.
- The weir should be in the middle of the dam with the sides tied into the slopes. (Like a smile ☺)
- Space check dams so that the bottom of the upstream dam should align with the weir of the downstream dam.
- Straw bales should be two rows wide. Filter socks should be placed three in a pyramid shape.
- Stake into the soil to securely anchor dams.

Inspection

- Inspect weekly and within 24 hours after a ½" or more rain event.
- Check to make sure center of dam is low and the sides are tied into the slopes so water flows across center of dam.
- Check for #5 or #8 filter stone on front face of dam. (when using filter socks).
- Geotextile under dam should extend 6 feet down slope.

Maintenance

- Remove sediment once it reaches one-half the height of the check dam.
- Repair or replace if damaged or ineffective.

Example Installations

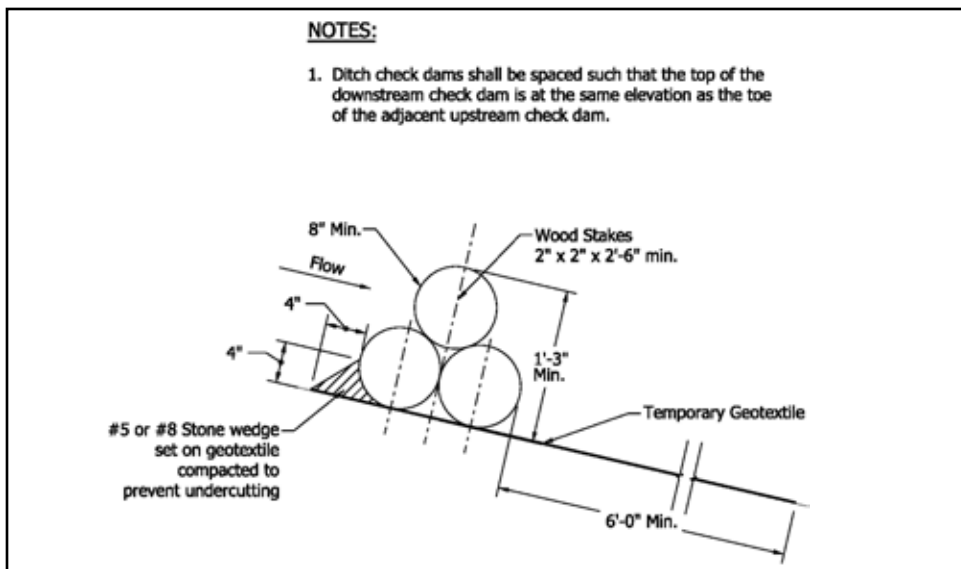

INDOT Standard Drawing of filter socks used as an alternative to straw bales. Installation should include three filter socks in a pyramid with geotextile underneath.



Straw bale check dams undermined due to high velocities, no geotextile and no trenching.



The water volume and velocity in this area are too much for traversable check dams. There should be more focus on erosion control with seed, mulch and erosion control blanket.



Straw bales should be two wide, not two high.



Standard References

Standard Specification Reference: 205.04 (c) Temporary Surface Stabilization
621.04 Preparation of Ground
621.05 (c-f) Mulch

Standard Specification Reference: N/A

Description

This BMP is a manufactured surface protection product. Erosion control blankets act as a specialized mulching material. They are normally used on long or steep slopes and in concentrated flow channels. The advantages that erosion control blankets provide include preventing erosion by protecting the soil from rainfall impact, overland water flow, concentrated runoff, or wind. The blankets are also anchored to help in the most critical areas. Blankets tend to conserve moisture and increase seed germination and seedling growth.

Installation

- Select the appropriate type of blanket needed specifically for the designated area and anticipated water velocity.
- The area shall be relatively free of all rocks or clods over 1½” in diameter
- Lay erosion control blankets on the seeded area so that they are parallel to the primary direction of water flow, in continuous contact with the soil, and with each upstream blanket overlapping the downstream blanket.
- Tuck the uppermost edge of the upper blankets into a check slot, backfill with soil and tamp down.
- Anchor the blankets in place by driving staples, pins, or stakes through the blanket and into the underlying soil.

Inspection

- Check for erosion or displacement of the blanket weekly and within 24 hours of a ½” or more rain.
- Blanket needs to be anchored and overlapped properly according to specification to ensure proper function.

Maintenance

- If any area shows erosion, pull back that portion of the blanket covering the eroded area, add soil and tamp, reseed the area, replace and staple the blanket.

Example Installations



Ditches without blankets will wash the mulch away, disabling grass from growing and leading to erosion.



Erosion control blankets will not work if proper soil and soil grading is not completed first. Blankets not installed parallel to direction of water flow.



Erosion control blankets should be placed from toe to top of the slope on side slopes.



Blankets can be used as temporary or permanent erosion control around hot spots such as creek banks.



Standard References

Standard Specification Reference: 616.05 Riprap
616.11 Geotextile under riprap

Standard Drawing Reference: N/A – Contract Specific Design

Description

The inlet protection is described as the permanent protection of the upstream side of culverts and pipes. Channel flow upon approaching a structure, pipe or culvert will constrict and increase velocity having to enter a smaller cross sectional area. This increased velocity can cause erosion around the structure in place. Typically, riprap is used on the upstream part of the structure to armor the areas affected by the increased velocity of the water flow.

Installation

- The area that will be affected must be identified before any geotextile or riprap is placed. In general, the riprap and geotextile should be placed slightly wider than the existing channel flowing at the structure.
- Geotextile must be placed at all the intended areas for riprap. The geotextiles shall be prepared to a relatively smooth condition free of obstructions, depressions, and debris.
- Place riprap on geotextile at depth shown on the plan and matching the plan location and grade.

Inspection

- Inspect weekly and within 24 hours of a ½" or more rain event.
- Ensure that the geotextile has been handled and placed according to specification.
- All riprap shall be placed on top of installed geotextile.
- Inspect for scour around the inlet and beyond the limits of the riprap.

Maintenance

- Promptly repair any erosion that forms.
- Replace geotextile if it has been damaged.
- Clean out or replace any riprap showing excessive sediment build-up.

Example Installations



The lack of permanent protection has caused scouring around pipe inlet.



Permanent inlet protection without Geotextile fabric and haphazard placement.



Pipe does not need riprap for permanent inlet protection because permanent vegetation was established for stabilization and velocity is low.



Permanent inlet protection includes wing walls and riprap protection.

Erosion Control



Standard References

Standard Specification Reference: 616.05 Riprap
616.11 Geotextile under riprap

Standard Drawing Reference: N/A – Contract Specific Design

Description

The outlet protection is described as the permanent protection of the downstream side of culverts and pipes. Channel flow within a structure, pipe or culvert will constrict and increase velocity upon exit. This increased velocity can cause erosion downstream of the structure. Typically, riprap is used on the downstream part of the structure to armor the areas affected by the increased velocity of the water flow.

Installation

- Geotextile must be laid out according to the plans and details. If no detail, use the estimated planned quantity for geotextiles and cover the bottom of the channel and at least halfway up the side slopes of the channel.
- Geotextile must be placed at all the intended areas for riprap. The geotextiles shall be prepared to a relatively smooth condition free of obstructions, depressions, and debris.
- Place riprap on geotextile at depth shown on the plans and matching the plan location and grade.

Inspection

- Inspect weekly and within 24 hours after a ½" or more rain event.
- Ensure that the geotextile has been handled and placed according to the specifications
- All riprap must be placed on top of installed geotextile.

Maintenance

- Promptly repair any erosion that forms
- Replace geotextile if it has been damaged.
- Clean out or replace any riprap with excessive sediment build-up.

Example Installations



Too much riprap has been placed within the channel. Riprap should be sumped to allow the waterway and box culvert to naturally fill with sediment over time and form a new channel above the riprap. Refer to and follow the IDEM 401 and USACE 404 permit conditions.



Outlet protection not shaped correctly. Water should flow down the middle of the riprap.



Ditch is properly sumped to create a natural flow line to eliminate erosion.



Outlet protection slows the velocity of water exiting the pipe to help prevent erosion.



Standard References

Standard Specification Reference: 616.01-08 Riprap, 616.10-11 Geotextiles

Standard Drawing Reference: N/A – Contract Specific Design

Description

Riprap is used as a means to slow the velocity of water in concentrated or channel flow to prevent channel erosion. Stone should be extended far enough up the slope to prevent scouring at the edge of the riprap. A riprap ditch is often placed where water volume or velocity is too high to establish adequate permanent vegetation. Riprap is used to stabilize a channel but should not be used to collect sediment.

Installation

- Ditch must be cut to final cross section/grade
- Place Geotextile on a relatively even surface. Overlap Geotextile sheets 18 inches with the upstream sheet over the downstream sheet.
- Riprap must be dumped and placed at the specified thickness shown on the plans
- Top of riprap must match the cross section grade. The finished surface shall vary no more than 9 inches from a true plane

Inspection

- Inspect weekly and within 24 hours after a ½" or more rain event.
- Verify riprap is was placed in the correct location and quantity shown in the plans and standard specifications
- Inspect for scour along the sides of and downstream of riprap channel.
- Inspect for sediment collecting in the riprap channel.

Maintenance

- If sediment is found in the riprap, stabilize slopes and areas upstream of channel. Clean out or replace riprap.
- If scour is found along the sides of the channel, reshape channel as needed for water to flow through the riprap.
- If scour is found downstream of the channel, additional riprap may be needed. Consult with designer and/or Environmental Services to ensure no permits or permit modifications are needed. Repair any damaged geotextiles.

Example Installations



Permanent riprap should be installed in steep ditches to prevent gully erosion.

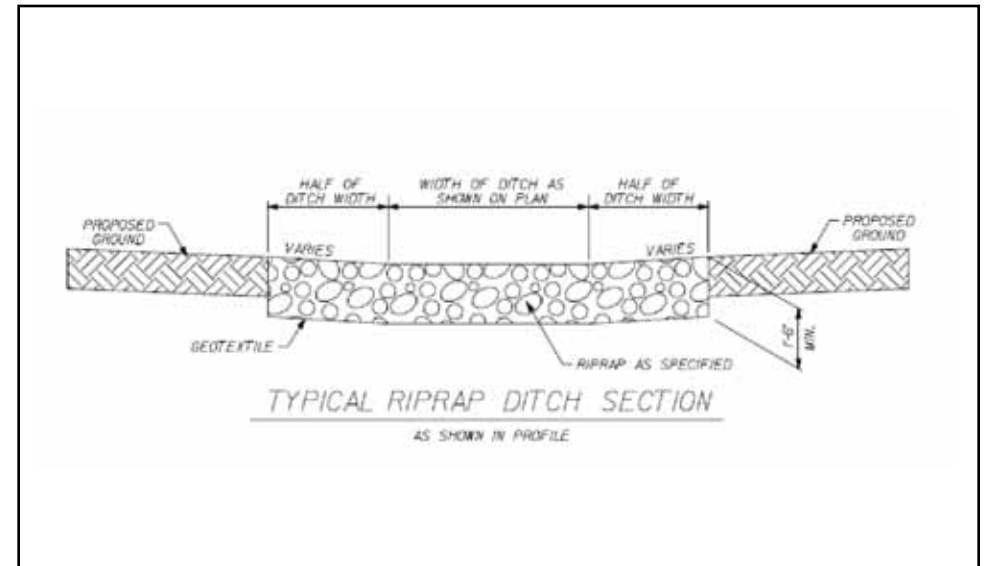

Typical riprap ditch section can be found in the plans.



Permanent riprap ditch with correct shape and placement.



Riprap is not extended far enough up the slope and not shaped correctly, causing scour.



Standard References

Standard Specification Reference: 621 Permanent Seed
914.01 Special Topsoil for Roadside Development

Standard Drawing Reference: N/A

Description

Permanent seeding is one method to provide vegetation to manage erosion. Thick permanent vegetation stabilizes slopes and minimizes maintenance years after the project is complete. Permanent vegetation also helps filter pollutants such as oils and nutrients. Timing of seeding is critical. September is the best time to plant seed due to the temperature and moisture. Seeding is allowed throughout the year per specification 621.12 but may need a warranty bond and/or watering.

Installation

- Topsoil should be capable of supporting normal vegetation, free of noxious weeds and shall be in accordance with the final cross section and grade.
- Topsoil shall have a pH value of 6.2 to 7.4. A soil test is recommended to determine if amendments are needed.
- Loosen topsoil to a minimum of 3 inches.
- Fertilizer shall be uniformly applied at 800 pounds per acre.
- Seed may be drilled or mixed with water and sprayed over area. Seed shall not be covered more than one-half inch.
- Permanent mulch shall be applied uniformly at 2 tons per acre within 24 hours after seeding.
- Alternatively, erosion control blanket can be used to protect seed and slope. Erosion control blanket is required on slopes steeper than 3:1.
- Punch mulch into soil with a mulch tiller.
- Unless seed was applied by a hydroseeder, water thoroughly.

Inspection

- Inspect weekly and within 24 hours after a ½" or more rain event.
- Areas should be monitored to ensure that mulch cover stays in place.
- With appropriate temperature and moisture, seed should germinate in approximately 2-3 weeks.

Maintenance

- Promptly repair any small rills that form and reapply seed and mulch as needed.
- If consistent rills or gullies are forming, consider installing slope drains or fiber rolls at the top of the slope until vegetation is established.
- If vegetation appears yellow or wilted, fertilizer and/or watering may be needed.

Example Installations



Mulch is not an appropriate protection for seed in concentrated flow areas.



Picture showing adequate mulch cover per visual inspection. Mulch provides protection from erosion and retains moisture needed for seed germination and grass growth.



Picture represents a higher than 70 percent uniform density permanent vegetation.



Poor soil conditions can hinder the vegetative growth.

Erosion Control



Standard References

Standard Specification Reference: 621.08-14 Permanent Sod

914.01 Special Topsoil for Roadside Development

914.07 Sod

Standard Drawing Reference: Sod typical drawing within plan details

Description

Installing permanent sod is one method to provide permanent vegetation to manage erosion. Thick permanent vegetation stabilizes slopes and channels and minimizes maintenance needed years after the project is complete. Permanent vegetation also helps filter pollutants such as oils and nutrients. Sod edges should be tightly butted together to help keep moisture in the soil and prevent air from drying out the grass roots.

Installation

- Topsoil should be capable of supporting normal vegetation and free of noxious weeds and have a pH value of 6.2 to 7.4.
- Loosen topsoil to a minimum of 3 inches. Soil shall be smooth, uniform and free of clods, lumps, boulders and waste material
- Fertilizer shall be applied at 400 pounds per acre and raked into 1-2" deep loose topsoil prior to laying sod.
- Notch the sod into the soil so that after installation, the surface is in accordance with the final cross section and grade.
- Lay sod in the direction of water flow. Tightly butt together to avoid open joints.
- Water immediately after laying the sod enough to saturate the sod and the top few inches of soil.
- After watering, tamp or roll to ensure contact with the soil. Surface shall be smooth and free from lumps and depressions.
- Secure sod in place with wood pegs or wire pins driven flush with top of the sod when required.

Inspection

- Inspect weekly and within 24 hours after a ½" or more rain event.
- Repair or replace sod that is no longer in contact with the soil or has moved.
- Monitor after the required minimum watering timeframe and water as necessary during dry and/or hot weather conditions.

Maintenance

- Water sod every day of the first week, once every second day of the second week, once every third day of the third week and once a week thereafter for a minimum of four weeks.
- During ample rainfall, watering may be modified to simulate the above schedule.

Example Installations



Area upstream of sodded ditch is not stable and causing sedimentation on permanent sod.



Permanent sod installed in concentrated flow area in median.



Sod installed in channel bottom with tight joints in the direction of water flow. Slopes should be stabilized to prevent sediment in the sod.

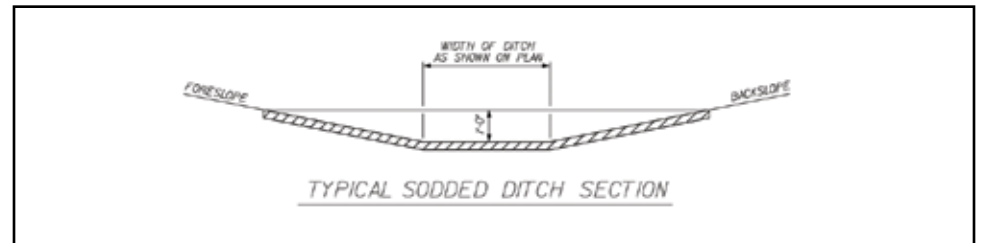

When placing sod in a ditch, extend the sod up the slope to prevent scour on the edge of the sod. Notch sod into the soil so that there is a smooth surface transition in accordance with the final cross section and grade.



Sod was not adequately watered or otherwise maintained.

Sediment Control

If all previous management efforts have been exhausted, sediment control BMPs will be needed to minimize sediment and other pollution from leaving the site. Sediment control measures are designed to slow water down long enough for sediment particles to settle. Smaller particles (such as clay) need more time in still water to settle than do larger particles (such as sand). Because of this, sediment control features are not very effective in areas with clay soils. This is why the focus should be on other management tools (Communication, Work Management, Storm Water Management and Erosion Control). Once soil is on the move, it's hard and expensive to manage. Generally, sediment control measures are the most expensive, require the most maintenance, and are the least effective storm water management tools.

Successful Strategies

Last Line of Defense

- Use all other Best Management Practices (Communication, Work Management, Storm Water Management and Erosion Control) so that sediment control measures do not need as much maintenance.
- Sediment control measures are like the safety position in football. An effective team uses all defensive players with the safety as the last line of defense.

Plan for Maintenance

- When sediment control measures are placed, install them in a location where they can easily be maintained. If the last measure cannot easily be maintained, consider additional measures that minimize maintenance needs.

Consider the Watershed

- Sediment control measures should be designed to handle the sediment load and storm water velocity of the entire watershed.
- If the watershed size is not known, existing features such as ditch size, pipe size, etc. will provide an indication of an appropriate sediment trap or basin size.



Standard References

Standard Specification Reference: 205.03 General Requirements
205.07 Maintenance

Standard Drawing Reference: E 205-TECP-01

Description

A construction entrance is a stone pad made of geotextile fabric placed under #2 stone. The construction entrance provides ingress and egress to a construction site and minimizes tracking of mud and sediment onto public roadways. Sediment on public roadways can cause a safety hazard due to slippery conditions, loose rocks and decreased visibility from dust. Sediment on roadways is a common complaint from citizens to regulatory agencies such as IDEM.

Installation

- Place geotextile fabric under #2 stone
- Construction entrances should be a minimum of 12' wide by 50' long. Ideally, if space allows, the entrance should be 150' long.
- Avoid placing on steep slopes or curves onto public roads.
- Do not block ditches. Install an appropriately sized culvert if traversing a ditch.

Inspection

- Verify that the entrances are where they are most effective. Is the location safe? Are the trucks entering and exiting in that location?
- Ensure the entrance has not interfered with existing drainage patterns.
- Inspect the entrance each day it is being used.
- Monitor tracking onto public roads and observe the sediment being collected in the stone. Redress or remove stone and sediment and replace with clean stone as necessary.

Maintenance

- Redress the #2 stone as necessary to provide clean stone with voids capable of trapping additional sediment.
- Remove stone and sediment and replace with clean #2 stone on construction entrances near sensitive areas (wetlands, streams, etc.) or where redressing could cause a safety (example: sight lines) or drainage problems.
- Sweep or otherwise remove sediment from public roads as necessary.
- Reshape, resize or relocate ineffective construction entrances.

Example Installations



Construction entrance not the minimum 50' long.



Insufficient #2 stone on construction entrance. Note tracking onto public roadway. Mud tracked onto paved roads is a common complaint from citizens.

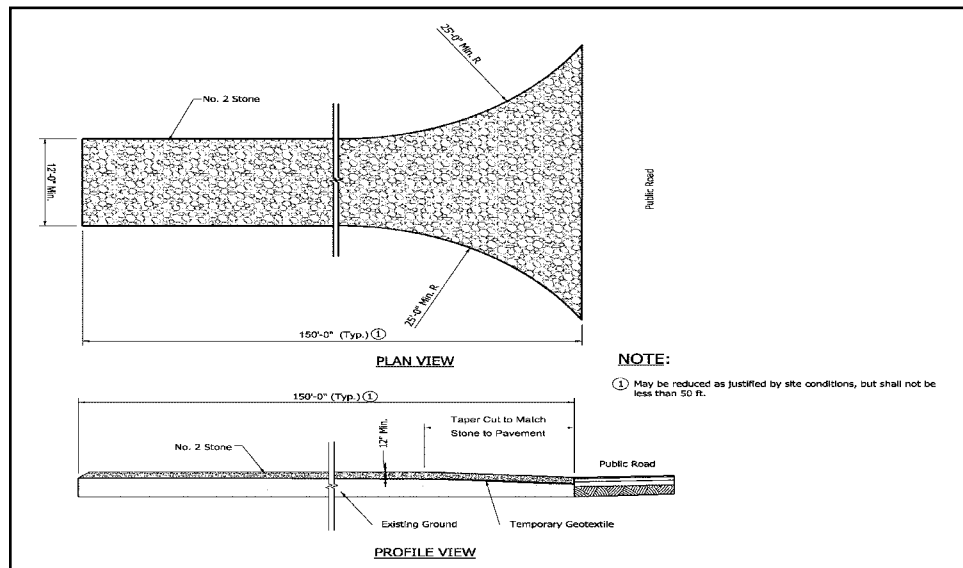

INDOT Standard drawing, Construction Entrance.



Construction entrance installed correctly, steep slope could not be avoided.



Standard References

Standard Specification Reference: 205.06 (a) Silt Fence
205.07 (a) Maintenance

Standard Drawing Reference: E 205-TECP-02

Description

Silt fences are used primarily as perimeter protection in sheet flow areas. Install silt fence to trap sediment from small, disturbed areas by reducing the velocity of sheet flow. Silt fences capture sediment by ponding water to allow deposition, not by filtration. Silt fence should not be used as a diversion and should not be installed across a stream, channel, ditch, swale, or anywhere that concentrated flow is anticipated.

Installation

- The contractor's Storm Water Quality Manager and the INDOT PE/PS should discuss silt fence locations prior to installation.
- Install prior to earthwork or clearing operations.
- Do not place silt fence in concentrated flow areas.
- Trench in the bottom of silt fence and install joints per the INDOT standard drawing.
- Place silt fence along a contour and "J" hook the ends to tie into the slope.
- Allow access for maintenance if possible. If maintenance access is impossible or difficult, plan additional erosion control measures to reduce the need for silt fence maintenance.

Inspection

- Inspect weekly and within 24 hours after a ½" or more rain event.
- Check for torn, decomposed or ineffective fence.
- Ensure fence is trenched in and placed along a contour.
- Check for sediment accumulations and areas where fence has fallen.
- Check for "J" hooks at the end of silt fence runs.

Maintenance

- Repair or replace silt fence if torn, starting to decompose, damaged by construction equipment, or is ineffective.
- At a minimum, remove sediment once it reaches one-half the height of the fence.

Example Installations



Silt fence is overwhelmed with sediment and requires maintenance.



Silt fence not trenched in.



“J” hook the end of the silt fence uphill to prevent water from bypassing fence.

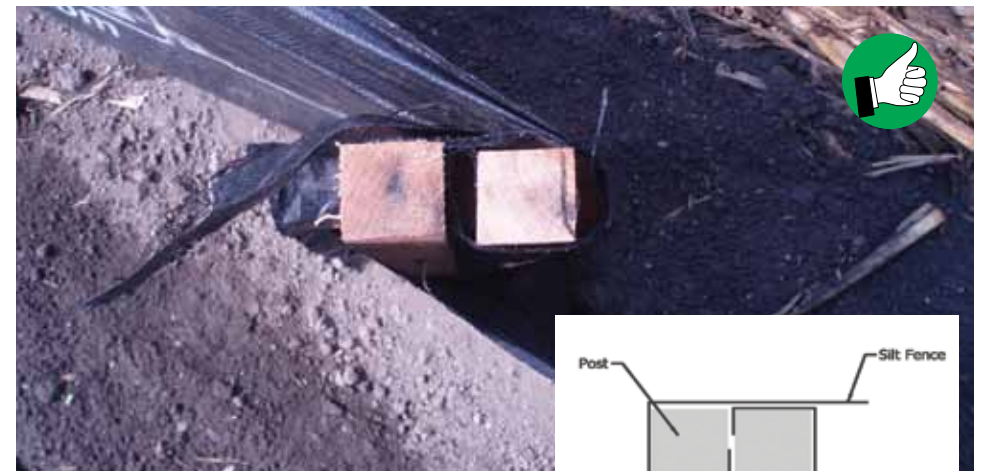

Joint between two segments of silt fence properly installed.

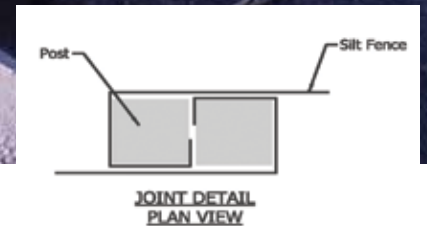



Standard References

Standard Specification Reference: 205.05 (d) Sediment Trap
205.07 (e) Maintenance

Standard Drawing Reference: E 205-TECD-03

Description

A sediment trap is placed to contain and minimize sediment release from construction areas by pooling storm water runoff and allowing time for settling of suspended soil particles. Sediment traps should be placed in ditches at the downstream end of the construction area or immediately before a ditch flows into a jurisdictional waterway such as a stream. Sediment traps are designed to treat runoff from up to five acres. If the watershed is more than five acres, a sediment basin should be constructed instead.

Installation

- Install in concentrated flow areas where water leaves the construction site.
- Traps should be sized for the watershed including on-site and off-site, disturbed, and stable areas.
- Use geotextile fabric, revetment riprap and #5 or #8 stone.
- Make sure outlet is stabilized with stone, vegetation, geotextile or other material.

Inspection

- Inspect weekly and within 24 hours after a ½" or more rain event.
- Water should drain within 72 hours of a rain event to regain the trap's storage volume.
- If the trap does not drain within 72 hours, check for clogged filter stone and sediment build up.
- Ensure trap is stable after a two-year storm event (approximately 3"). If not, trap is undersized or a series of measures are needed.

Maintenance

- Remove sediment once the sediment trap is one-half full.
- Replace filter stone when water does not drain within 72 hours.

Example Installations



Sediment trap without filter stone allows sediment to travel through riprap and into waterway.



Trap placed too far away from waterway, should have a stable outlet to the creek and needs maintenance.



Sediment trap placed at the end of the ditch right before a waterway.



Sediment trap placed in an appropriate location close to stream with filter stone.



Standard References

Standard Specification Reference: 205.05 (e) Sediment Basin
205.07 (b) Maintenance

Standard Drawing Reference: N/A. Contract specific design

Description

Sediment basins consist of an embankment constructed basin with a riprap and filter stone encased perforated stand pipe near the downslope side. The stand pipe outflows through a connected buried pipe within the downslope embankment wall. Sediment basins are placed in order to minimize sediment release from construction areas by pooling storm water runoff and allowing time for the suspended soil particles to settle out of the storm water. They are contract specific and designed to accommodate storm water runoff and sediment from large areas. Sediment basins are designed to treat runoff from approximately 5 to 30 acres and should be placed as close to the sediment source as possible.

Installation

- The INDOT PE/PS and the Contractor's Storm Water Quality Manager should discuss the locations and sizes of the designed sediment basins prior to installation.
- Install sediment basins in concentrated flow areas where water leaves the construction site.
- Basins should be sized for watersheds that include on-site and off-site areas and should also account for both disturbed and stable areas. They should accommodate no more than 30 acres.
- Ensure the basin has stable slopes, stable outlet overflow, perforated stand pipe placed to the correct height (2' below the top of basin), and #5 or #8 filter stone surrounding the riprap core.
- Make sure the outlet is stabilized with stone, vegetation, geotextile or other suitable material.

Inspection

- Inspect weekly and within 24 hours after a ½" or more rain event.
- Check to ensure that the basin drains within 72 hours of a rain event.
- Check for clogged filter stone and sediment build up.

Maintenance

- Remove sediment once design volume (check plans) is reached.
- Replace filter stone when water does not drain within 72 hours.

Example Installations



Sediment basin slopes are not stable and no filter stone is used on perforated stand pipe.



Sediment basin overflow pipe is installed too high. Pipe opening should be at least 2' below the stable overflow weir. Basin not sized to handle 5+ acre watershed.



Sediment basin stabilized with vegetated banks, riser pipe and stable overflow.



Sediment basin with stable slopes, stable outlet, filter stone and stand pipe. However, stand pipe installed too high as compared to surrounding land and outlet elevation.



Standard References

Standard Specification Reference: 205.06 (b) Filter Berm
205.07 (c) Maintenance

Standard Drawing Reference: N/A

Description

Filter berms are used to trap sediment from long linear, disturbed areas by reducing velocity of sheet flow. Filter berms capture sediment by filtering storm water runoff and by ponding smaller amounts of water at their base to allow settling and deposition. A filter berm can be constructed with rock, compost or filter socks. Only rock filter berms can be used where more concentrated flows are anticipated.

Installation

- Discuss the locations, materials and timing of the construction of filter berms with the Contractor's Storm Water Quality Supervisor.
- Install filter berms along the perimeter of the construction area close to locations where runoff would enter an adjacent waterway in primarily sheet flow areas. Only rock filter berms can be installed for concentrated flow areas.
- Rock filter berms should include geotextile fabric with riprap placed on top. #5 or #8 filter stone should be added to the upslope side of the riprap berm.
- Wood chips from tree clearing operations or filter socks can be used as filter berms, but only where water velocity is low.

Inspection

- Inspect weekly and within 24 hours after a ½" or more rain event.
- Monitor for sediment accumulation.
- Look for areas that have been damaged by storm water or equipment.

Maintenance

- Remove sediment once it reaches one-quarter the height of the berm.
- Repair damaged areas as needed or directed.

Example Installations



Filter berm after a large rain event that needs maintenance.



Filter berm protecting creek from long fill slope. Note existing vegetation left in place along creek bank.



Filter berm protecting creek with geotextile, revetment riprap and filter stone. Note existing vegetation left in place between filter berm and waterway.



Filter berm protecting newly constructed stream mitigation.



Standard References

Standard Specification Reference: 205.06(b) Filter Berm
205.07 Maintenance

Standard Drawing Reference: E 205-TECD-02 as traversable check dam

Description

Filter Socks are versatile filter devices that can be used in a few different applications such as a filter berm, perimeter protection or traversable check dam. Filter socks are mesh tubes usually filled with organic material such as straw that are staked into the ground. They are designed to slow runoff water velocity, filter sediment and temporarily pond small amounts of water. If filter socks are used as traversable check dams, they should be used only in clear zones with adjacent active traffic lanes and low storm water velocities. Filter socks are a good choice for tree clearing areas where roots prevent trenching in of silt fence.

Installation

1. Traversable check dam

- Install three horizontal rows to form a pyramid and secure with stakes
- Install geotextile fabric below the socks and extend the fabric downstream to prevent scour.
- Shape with a lower center and sides tied into the slopes (like a smile ☺) when used within a ditch line.

2. Filter berm

- Install in sheet flow areas with small watersheds and low velocities.
- Secure into soil with wooden stakes.
- Can be used at the top of slopes to reduce runoff velocity and help vegetation establishment.

Inspection

- Inspect weekly and within 24 hours after a ½" or more rain event.
- Monitor sediment accumulation and remove once it reaches one-quarter of the height of the filter berm.
- Look for areas that have been damaged by storm water or equipment.

Maintenance

- Replace or resecure damaged filter socks.
- Replace with rock or a stronger measure if damage is severe or reoccurring.
- Remove accumulated sediment once it reaches one-quarter of the height of the filter berm.

Example Installations



Filter sock used as traversable check dam in the clear zone (good) but installed where water velocity is very high (bad). No geotextile was used and only one filter sock was used (verses three in a pyramid).



Filter socks can be placed horizontally across a slope to shorten a slope's length and prevent rill and gully erosion.

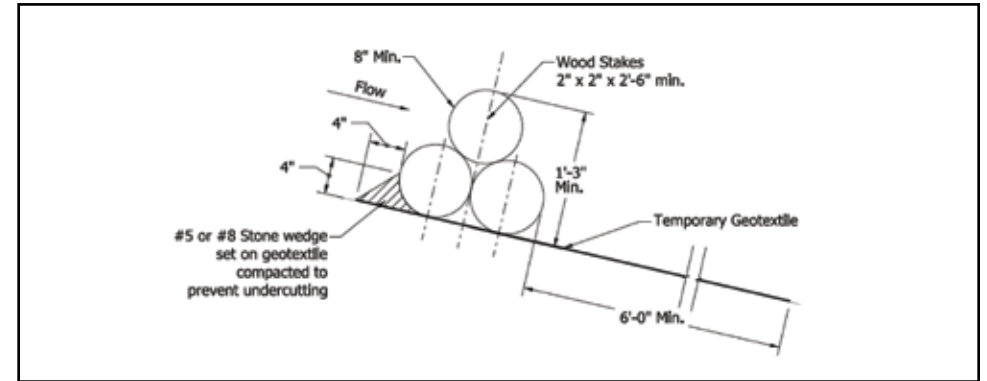

Standard Drawing showing filter socks used as traversable check dam.



Filter socks can be used on the edge of pavement to slow water before vegetation is established.



Filter socks used for channel stabilization.



Standard References

Standard Specification Reference: 205.05 (i) Inlet Protection
205.07 (d) Maintenance

Standard Drawing Reference: E 205-TECI-01 through E 205-TECI-06

Description

Inlets are designed to carry moderate and large flows of storm water. Inlets transport sediment to streams, rivers, wetlands and lakes if they are not properly protected. This sediment control measure can be the last chance to remove sediment before storm water leaves the job site. Inlet protection can take many forms and a review of the standard drawings listed above will better illustrate these methods. The choices of methods will allow for a “best fit” solution to specific construction situations.

Installation

- Discuss the inlet protection methods with all personnel involved in the installation.
- Install the specified inlet protection so that storm water does not bypass the inlet
- Install top cross bracing and trench in silt fence when using geotextile box.
- Use #8 filter stone and #2 coarse aggregate for gravel ring.
- Follow the standard drawing and/or manufacturers installation information (when using a commercially available product) when installing inlet bag type protection for inlets.
- Do not place this type of protection within any jurisdictional waterways.

Inspection

- Inspect weekly and within 24 hours after each rain event.
- Look for damaged, clogged or ineffective materials.
- Make sure storm water is not bypassing or undercutting any type of inlet protection that has been installed.

Maintenance

- Remove sediment after each storm event
- If measure is repeatedly damaged or clogged, consider additional erosion and sediment control measures upstream in a series.
- Cleaning by flushing with water will not be allowed

Example Installations



Geotextile placed under inlet is not an acceptable inlet protection measure. Geotextile will clog causing standing water, making measure impossible to maintain without getting muddy water into storm system. Ponding water could cause traffic hazards or muddy construction conditions.



Filter sock inlet protection staked correctly.



Inlet bag protection can be used on curb inlets with active traffic. Maintain bags after each storm event. Bags can get heavy and hard to maintain when very full.



No cross bracing used on inlet protection. Silt fence not trenched properly.



Standard References

Standard Specification Reference: 205.05 (i) Inlet Protection
205.07 (d) Maintenance

Standard Drawing Reference: N/A. Shown in plans

Description

Culverts are designed to carry moderate to large flows of storm water. Sediment from storm water runoff can be transported through unprotected or under-protected culverts into streams, rivers, wetlands and lakes. Culvert inlet protection can easily become the last measure to remove sediment from storm water before it leaves the job site. Culvert inlet protection should be constructed using methods similar to permanent culvert protection methods. The use of rock rings is also considered to be an acceptable culvert inlet protection measure.

Installation

- Review and discuss with all individuals involved in the installation process the methods and locations for culvert inlet protection measures.
- Install culvert inlet protection as indicated within the plans.
- Use #5 or #8 filter stone around the perimeter of the revetment riprap basin material.
- Do not place culvert inlet protection in jurisdictional waterways.

Inspection

- Inspect weekly and within 24 hours after a ½" or more rain event.
- Look for clogged or ineffective materials.
- Make sure storm water is not bypassing or undercutting the installed method of culvert inlet protection.

Maintenance

- Remove sediment after each storm event. Replace filter material if it becomes overly choked with sediment.
- If the protection measure is repeatedly clogged or overburdened, consider additional erosion and sediment control measures placed further upstream in a series.

Example Installations



Silt fence should not be located in concentrated flow areas and is not appropriate as culvert inlet protection.



Although not an INDOT standard, straw bales and riprap functioning well for culvert inlet protection.



Inlet protected from sediment with filter stone surrounding riprap.



Culvert inlet protection not shaped correctly contributing to scour around inlet.

Other Pollution Prevention

Exposed soil and sediment are not the only pollutants exposed to storm water on construction sites. Other pollution prevention methods should be utilized to protect the environment when constructing and maintaining roads and bridges. Careful handling and storage of construction materials will help ensure our natural resources are protected.

Successful Strategies

Protect Natural Resources

- Locate stockpiles, temporary toilets, fueling operations, etc. as far away from sensitive areas such as streams and wetlands as possible.
- Remove cofferdams, temporary crossings and other features within streams, as carefully as possible. Do not over excavate or churn up muddy water unnecessarily.

Treat Chemicals with Care

- Ensure the concrete washout is adequately sized and is completely contained. Chemicals in concrete washout raise pH levels and can cause fish kills in streams and prevent vegetation from growing in soils contaminated with the run-off.
- Store chemicals such as fertilizers, petroleum products and sealants inside if possible. Always protect chemicals in sealed containers so there is no exposure to storm water.
- Use secondary containment for all fuel storage.

Maintain Equipment

- Ensure all equipment is maintained in good working order. Fix fuel, oil or other fluid leaks as soon as they are discovered.
- Remove contaminated soils or otherwise clean up the job site due to these leaks immediately.



Standard References

Standard Specification Reference: 107.02 Permits, Licenses and Taxes
205.07 Maintenance

Standard Drawing Reference: N/A. Designed for specific site conditions.

Description

A temporary crossing is intended to be installed in a stream or waterway for short-term use by construction vehicles or heavy equipment. Temporary stream crossings are individually designed and are specific to the stream and conditions encountered at the site. If the crossing has not been included as part of the plans, the contractor is responsible to develop and submit for approval the design for the crossing. If not covered under the IDEM 401 and USACE 404 permits, the contractor is responsible for obtaining permits for temporary impacts such as crossings, cofferdams and demolition of structures.

Installation

- Have discussions with all those involved in the installation to determine and clarify the construction methods and procedures, and to ensure proper permitting of the crossing prior to construction.
- Crossings should be placed to disturb as little of the existing stream bed and banks as possible and sized to carry a minimum of a two-year, 24-hour storm event. Construct the overflow for 10-year, 24-hour storm.
- Temporary crossings should be constructed with riprap large enough to not allow the stone to wash down stream.
- Re-grade, re-seed or otherwise stabilize areas of removed vegetation.

Inspection

- Inspect weekly and within 24 hours after a ½" or more rain event.
- Check for accumulation of debris and obstructions such as limbs, trash, rocks, etc. at culvert openings; remove promptly as needed.
- Inspect for erosion of stream banks and approach road and repair promptly as needed.
- Inspect for sediment accumulation in the stone and replace as needed.

Maintenance

- Remove debris or other obstructions and repair eroded areas promptly.
- Periodically remove built up sediment carefully to ensure 10-year, 24-hour overflow is maintained. Replace the sediment laden stone as needed.
- When no longer needed, remove the crossing with as little creek disturbance as possible.

Example Installations



Pipes under temporary crossing are undersized causing creek to widen upstream.



#2 stone on temporary crossing needs to be redressed to reduce sediment entering creek during rain events.



Temporary crossing with adequate pipe capacity. These temporary impacts must be permitted, usually by the contractor, prior to installation and should be removed as soon as practical.



Construction entrance with geotextile and #2 stone constructed from road to temporary crossing to stabilize slope and reduce sediment tracking to the waterway.



Standard References

Standard Specification Reference: 108.04 Prosecution of the Work
205.07 Maintenance

Standard Drawing Reference: N/A

Description

Material storage and staging operations contain many pollutants harmful to humans and aquatic life. These pollutants need to remain isolated from storm water to prevent pollution from entering water bodies, exiting the site or leaching into the soil. Place fuel and other hazardous materials as far away from sensitive areas as possible such as creeks, wetlands, inlets.

Installation

- Discuss spill prevention plan with all personnel using the material storage and staging areas.
- Be ready to handle spills of petroleum or other noxious substances by having a written plan, spill kits, and containment materials on-site, especially near fueling or equipment service areas. Keep spill kits readily accessible and near where a spill may occur.
- Locate material storage, staging, fueling operations, equipment maintenance, and temporary toilet facilities away from hot spots such as waterways, wetlands and inlets.
- Hazardous materials (i.e. flammable paints, solvents), hazardous waste, and petroleum products should be stored in a trailer or other structure to avoid spills and runoff.
- Provide additional erosion and sediment control measures for the material storage and staging area(s).

Inspection

- Inspect daily.
- Check for soil stains indicated a fuel, oil or other leaks.
- Ensure materials are stored in proper containers, indoors or have secondary containment as required.

Maintenance

- Call the IDEM Spill Hotline at (888) 233-7745 for all reportable environmental emergency spills.
- Remove contaminated soil from leaks immediately.
- Keep construction site free of debris and remove trash.

Example Installations



Locate fueling operations, temporary toilets and staging away from waterways and other hot spots.



Keep construction debris contained in designated areas, away from hot spots and BMPs.



Good housekeeping includes trash collection.



Prevent fuel or other toxic spills. Locate spill cleanup kits in accessible areas and clean up immediately.



Standard References

Standard Specification Reference: 205.03 General Requirements
205.07(f) Maintenance

Standard Drawing Reference: N/A

Description

Concrete washout areas are designated locations, either a prefabricated unit or built measure, designed to completely contain concrete slurry. Uncured concrete and associated liquids are highly alkaline, and if not contained, may leach into the soil and contaminate ground water or a water body, elevating the pH to harmful levels. Elevated pH levels in the soil may also prevent vegetation growth.

Installation

- Choose washout location near a road for easy truck access.
- Size the washout to ensure adequate capacity for the day's operations.
- Create a structure or excavate a hole in the ground large enough to completely contain concrete slurry.
- Use one continuous sheet of plastic to line the washout. Do not overlap 2 or more sheets. Any overlap or tear in the plastic will allow the chemicals to be released.
- Secure plastic with stakes, stone or other.
- Place sign next to washout and ensure all drivers are aware of its location.
- Never washout into storm drains, bodies of water, wetlands, adjacent properties, vegetation or soil.

Inspection

- Make sure all concrete slurry can be contained within the washout provided. Construct additional washouts as needed.
- Inspect daily during concrete pour operations.
- Ensure washout is completely contained with one sheet of plastic free of tears.
- Dispose of cured concrete per specifications.

Maintenance

- Repair or replace if leaks, spills or tears are found.
- Provide additional concrete washouts as needed to ensure adequate capacity.

Example Installations



Concrete washout not contained.



Concrete washout should have one continuous sheet of plastic. Overlapping layers allows chemicals access to the soil below.



Concrete washout that is properly contained, close to capacity and appropriately located along access road.



Concrete washout contained within a container with signage.

Definitions

BMP – Best Management Practice

Contour – A line that represents a specific elevation

Flow

- **Sheet** – overland water moving in a continuous sheet over relatively even ground.
- **Concentrated** – sheet flow will eventually collect and transition to shallow concentrated flow.
- **Channel** – concentrated flow in a defined path such as a ditch bottom.

Gravity Dewatering – Removal of water from an area using a change in grade rather than a pump.

Gully – Larger erosion channel formed as rills concentrate.

IDEM – Indiana Department of Environmental Management

IDEM 401 – Indiana Department of Environmental Management Water Quality Certification

INDOT – Indiana Department of Transportation

INDOT-ES – Indiana Department of Transportation Environmental Services

Jurisdictional Waterway – Also known as a “Waters of the US”. Generally, these are wetlands, lakes, streams, rivers, etc. that shall not be dredged, filled or otherwise altered without a permit.

Karst – landscape features such as sinkholes, caves and underground streams formed from dissolving of rock like limestone.

NOI – Notice of Intent (Rule 5) is a document that is submitted to IDEM that includes specific project information and confirms the intent to comply with Rule 5. This document should be posted at the job site.

NOS – Notice of Sufficiency (Rule 5) is a letter from IDEM confirming the receipt of all NOI submittal requirements. This letter contains the permit number and expiration date and should be posted at the job site.

NOT – Notice of Termination (Rule 5) is a document submitted to IDEM confirming the completion of the project and termination of the permit.

pH – a scale from 0-14 indicating if a substance is acidic or alkaline (or basic), with 7 indicating neutral. Low numbers indicate acidic substances, high numbers indicate alkaline substances.

Rill – Small erosion channel only a few inches in depth.

Rule 5 – Indiana state law requiring erosion and sediment control for construction activities. (327 IAC 15-5) (<http://www.in.gov/idem/4902.htm>)

SWPPP – Storm Water Pollution Prevention Plan

USACE – United States Army Corps of Engineers

USACE 404 – United States Army Corps of Engineers Section 404 (of the Clean Water Act) Permit

Watershed – An area of land where all of the water drains to one place.

Weir – The lowest point on a structure where water is designed to flow across.

Wetlands – An area of saturated water with soil and plant material specific to that environment.

Velocity – The speed in which something moves.

Decision Making Matrix for Erosion and Sediment Control

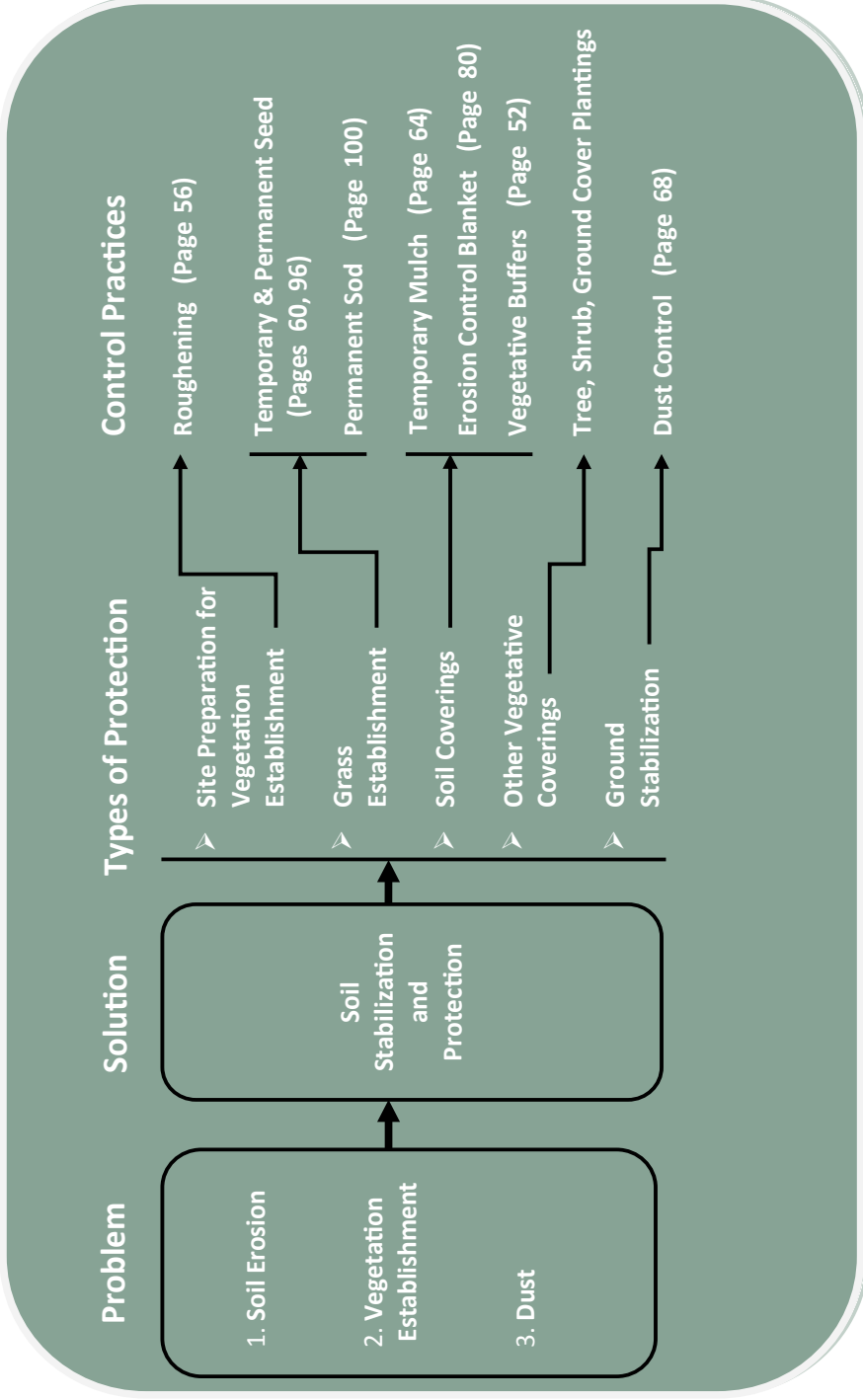

Decision Making Matrix for Erosion and Sediment Control

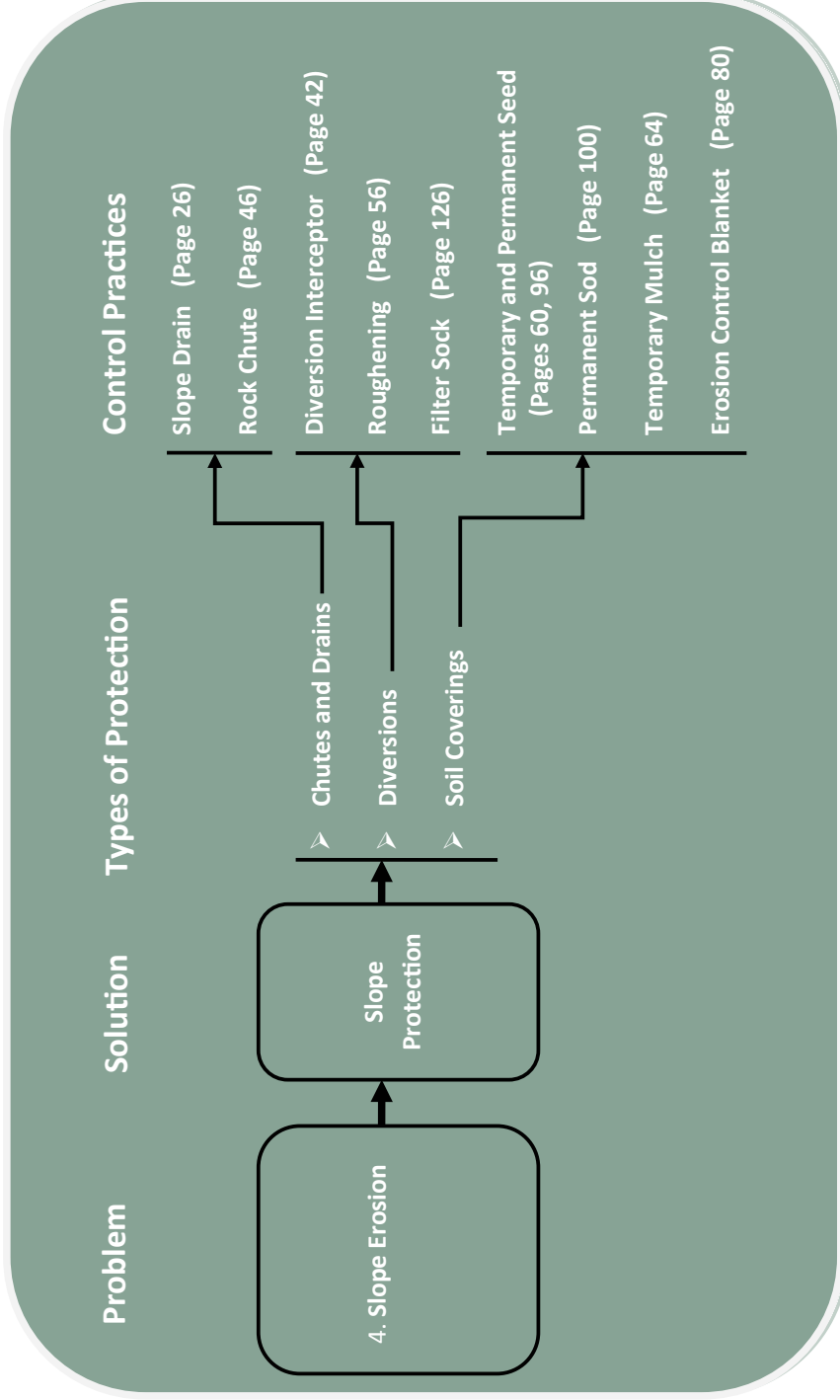

Decision Making Matrix for Erosion and Sediment Control

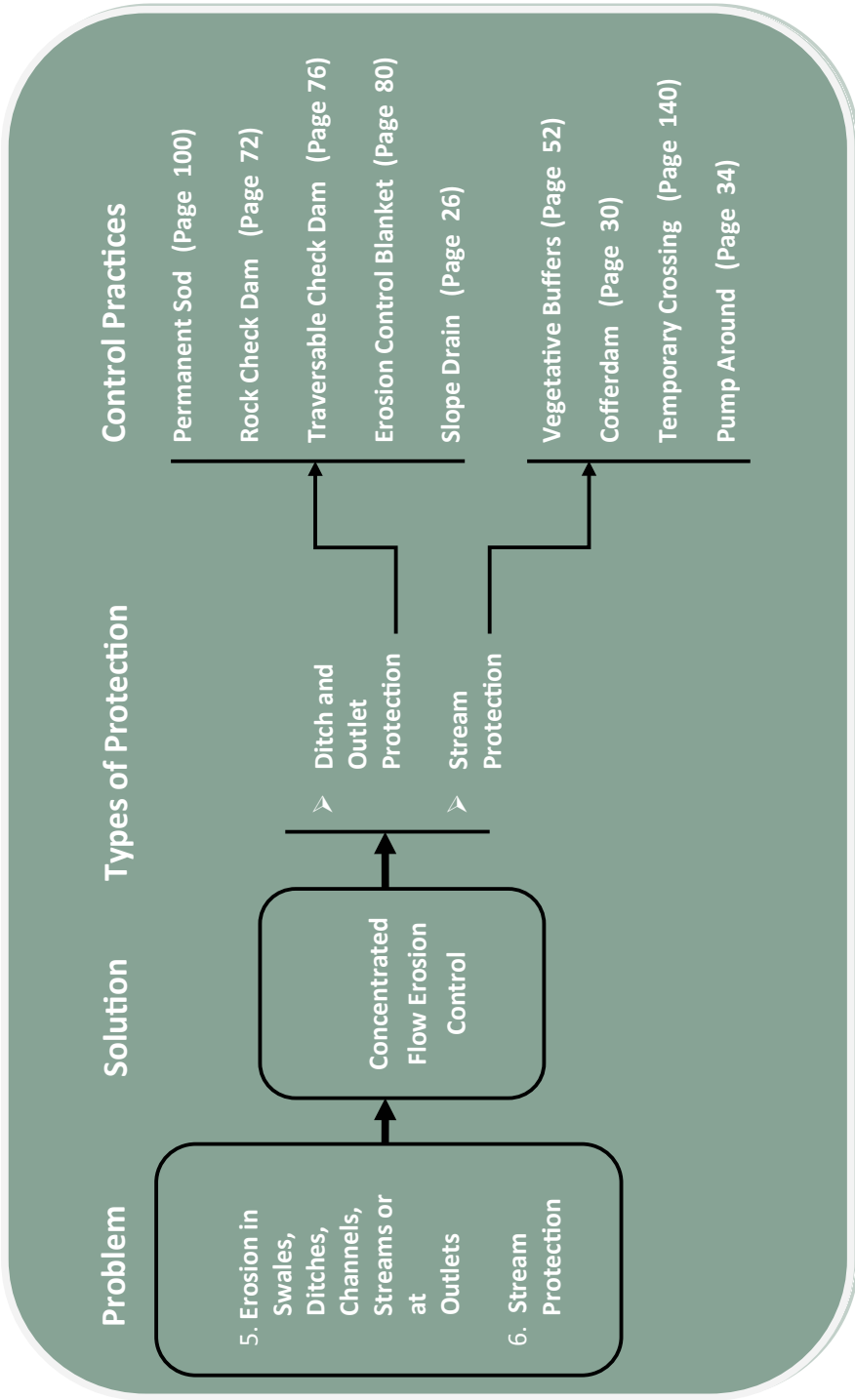

Decision Making Matrix for Erosion and Sediment Control

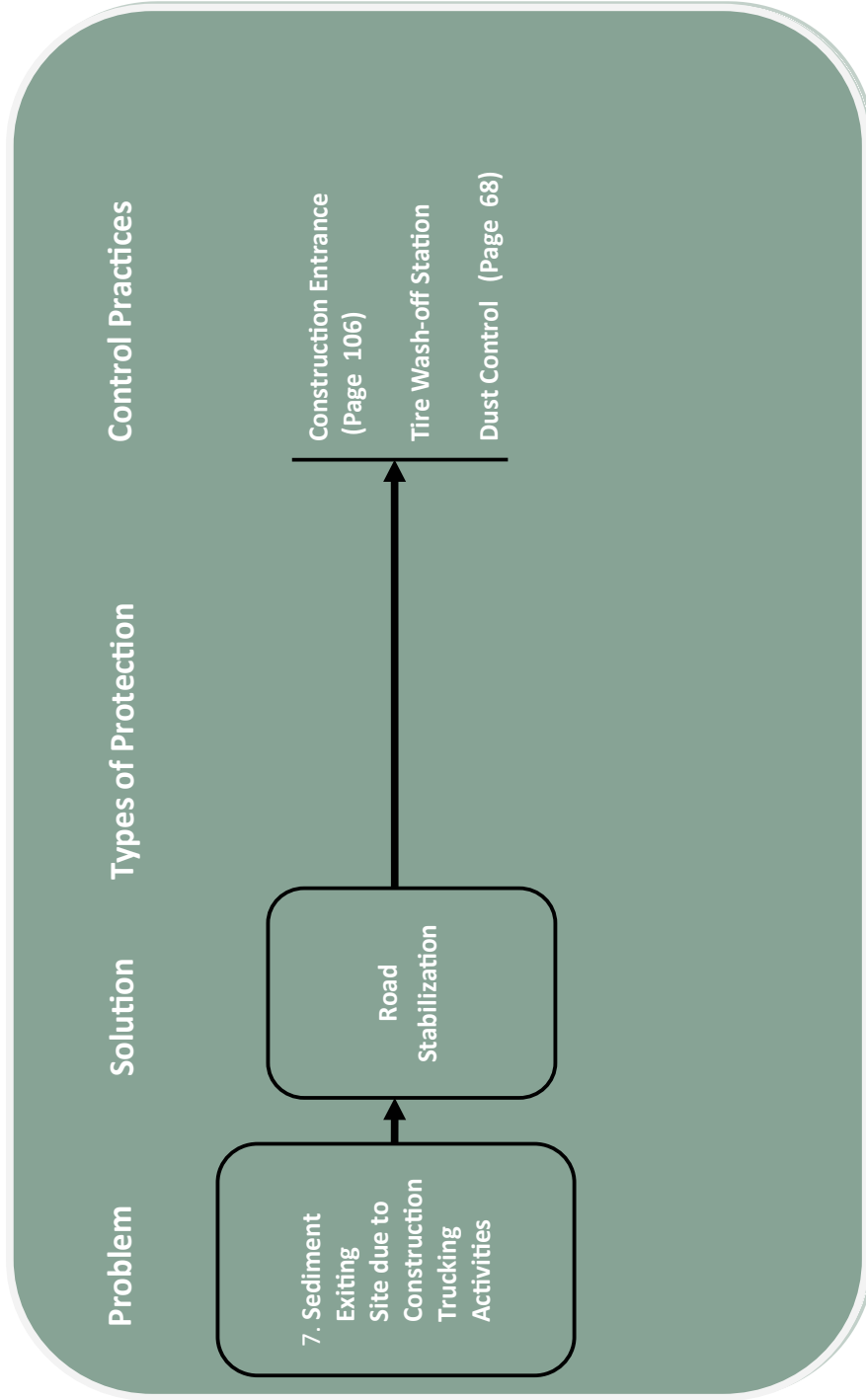

Decision Making Matrix for Erosion and Sediment Control

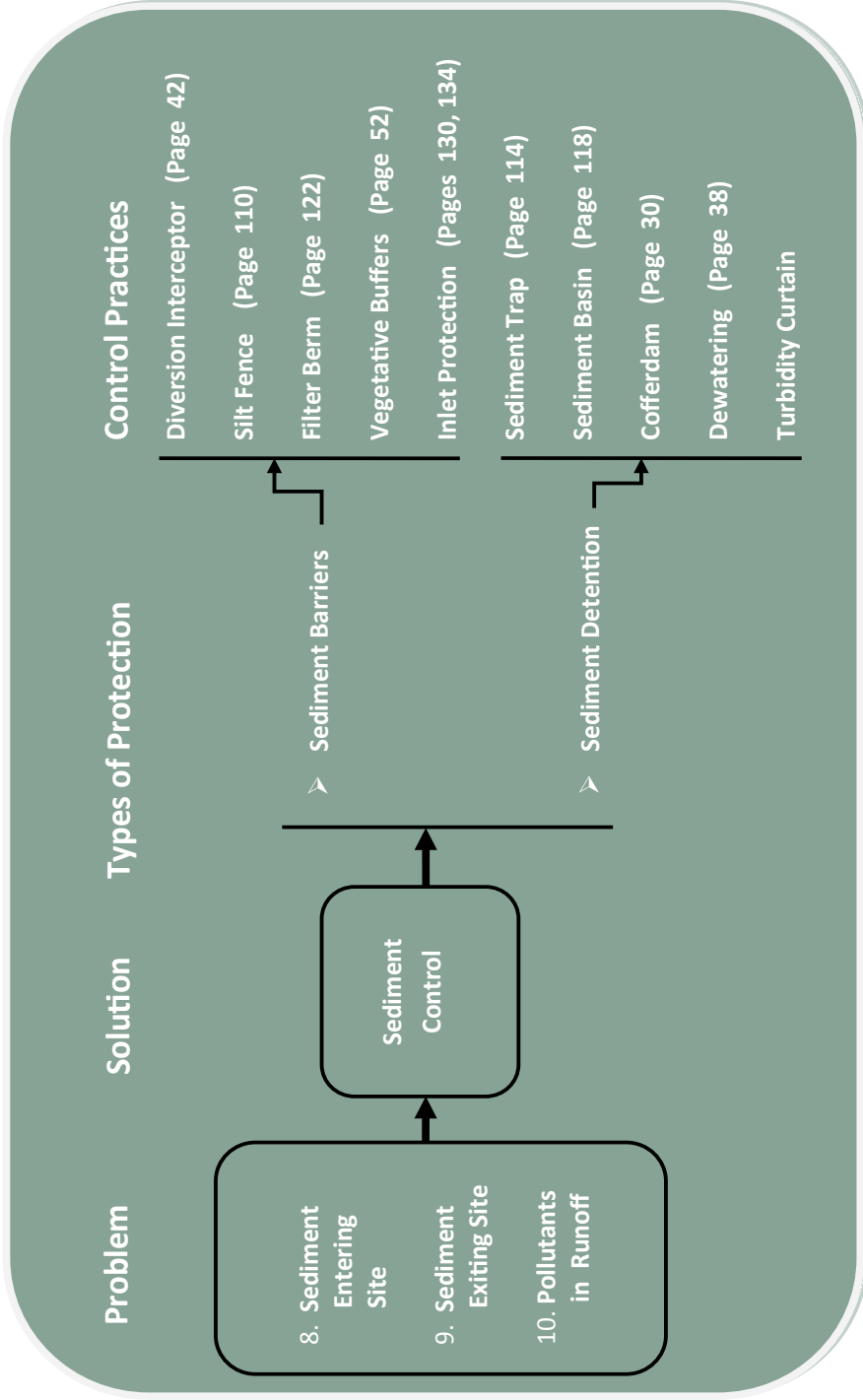

References

IDEM Emergency Response # 1-888-233-7745

http://www.in.gov/idem/files/er_quickref.pdf

Indiana Storm Water Quality Manual

<http://www.in.gov/idem/4899.htm>

IDEM Rule 5 (327 IAC 15-5)

<http://www.in.gov/idem/4902.htm>

INDOT Links

Project Specific Documents

<http://www.in.gov/dot/div/contracts/letting/index.html>

INDOT Recurring Special Provisions

<http://www.in.gov/dot/div/contracts/standards/rsp/index.html>

INDOT Request for Approval of Borrow or Disposal Site (IC 203 R3 11/09)

<http://www.in.gov/dot/div/contracts/standards/forms/IC-203.pdf>

INDOT Standard Drawings

<http://www.in.gov/dot/div/contracts/standards/drawings/index.html>

INDOT Standard Specifications

<http://www.in.gov/dot/div/contracts/standards/book/index.html>

General Instructions to Field Employees (GIFE)

<http://www.in.gov/dot/div/contracts/standards/GIFE/GIFEindex.html>

INDOT Environmental Services Storm Water Link

<http://www.in.gov/indot/2892.htm>



www.in.gov/indot